

Maxwell's Core Equations

**Exact, Universal,
and
Scary
for that reason**

**Robert S. Eisenberg
Bard Endowed Professor and Chair, emeritus
Department of Physiology and Biophysics
Rush University**

**Adjunct Professor
Department of Applied Mathematics
Illinois Institute of Technology**

**Chicago IL
USA**

DOI: 10.13140/RG.2.2.24122.31687

April 14, 2021

COMPUTATIONAL AND APPLIED MATH SEMINAR

Presented March 29, 2021

Thanks to
Arkadz Kirshtein, James Alder and Xiaozhe Hu
for the invitation and interest

Tufts Math Department

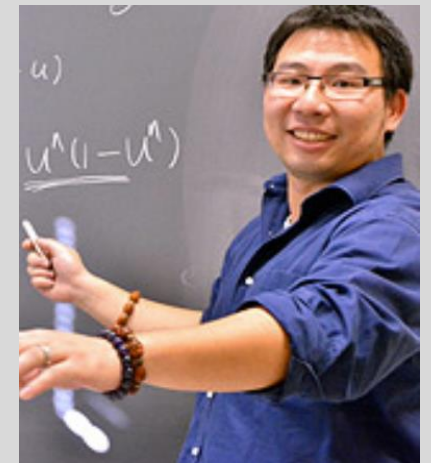

April 14, 2021

Abstract

DOI: 10.13140/RG.2.2.24122.31687

When the Maxwell equations are written without a dielectric constant, they are universal and exact, for biological and technological applications, from inside atoms to between stars. Dielectric and polarization phenomena need then to be described by stress strain relations for charge, that show how charge redistributes when the electric field is changed, in each system of interest.

Conservation of total current (including the ethereal displacement current $\epsilon_0 \partial E / \partial t$) is then as exact as the Maxwell equations themselves and independent of any property of matter. It is a consequence of the Lorentz invariance of the elementary charge, a property of all locally inertial systems, described by the theory of relativity.

Exact Conservation of Total Current allows a redefinition of Kirchhoff's current law that is itself exact. In unbranched systems like circuit components or ion channels, conservation of total current becomes equality. Spatial dependence of total current disappears in that case. Hopping phenomena disappear. Spatial Brownian motion disappears. The infinite variation of a Brownian model of thermal noise becomes the zero spatial variation of total current.

Maxwell's Core Equations become a perfect (spatial) low pass filter.

An Exact and Universal theory of Electrodynamics is a scary challenge to scientists like me, trained to be skeptical of all sweeping claims to perfection.



**Mathematics
describes only a tiny part of life,**



April 14, 2021

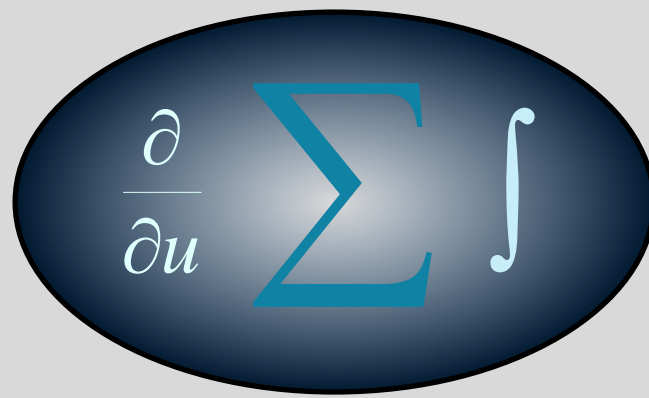

But
Mathematics* Creates
our
Standard of Living

Electronics, Electricity, Computers, Mobile Phones, TV, Games
and Fluid Dynamics, Optics, Structural Mechanics,

Essence of Electrodynamics
is
Maxwell's Core Equations
for the
Flows and Forces of Charge and Current
in matter and space

**Nearly Exact and Universal from Stars
to inside atoms**

Eisenberg, Oriols, and Ferry (2017) Dynamics of Current, Charge, and Mass.
Molecular Based Mathematical Biology 5:78-115 and arXiv preprint <https://arxiv.org/abs/1708.07400>.

Maxwell's Core Equations

Describe Electricity with errors $<10^{-6}$
in biological and technological applications

$$\mathbf{div} \mathbf{E} = \frac{\rho}{\epsilon_0}$$

$$\mathbf{div} \mathbf{B} = 0$$

$$\mathbf{curl} \mathbf{E} = -\frac{\partial \mathbf{B}}{\partial t}$$

$$\mathbf{curl} \mathbf{B} = \mu_0 \left(\mathbf{J} + \epsilon_0 \frac{\partial \mathbf{E}}{\partial t} \right)$$

\mathbf{E} is electric field, \mathbf{B} is magnetic field

\mathbf{J} is the current of all mass, including brief dielectric transients of the \mathbf{P} and \mathbf{D} fields

ρ is charge density (of all types, including dielectric charge of the \mathbf{P} and \mathbf{D} fields)

ϵ_0 is the permittivity of a vacuum

μ_0 is the permeability of a vacuum

$(\mu_0 \epsilon_0)^{-0.5} = \text{velocity of light (!)}$



Advanced Photon Source Argonne National Laboratory

Error in Theory
 $< 10^{-10}$

Beam $\sim 10^{10}$ eV
 Beam length 10^3 m
 Tolerance $< 10^{-7}$ m
 Beam Current 100 mA
 Beam Power 10^9 watts

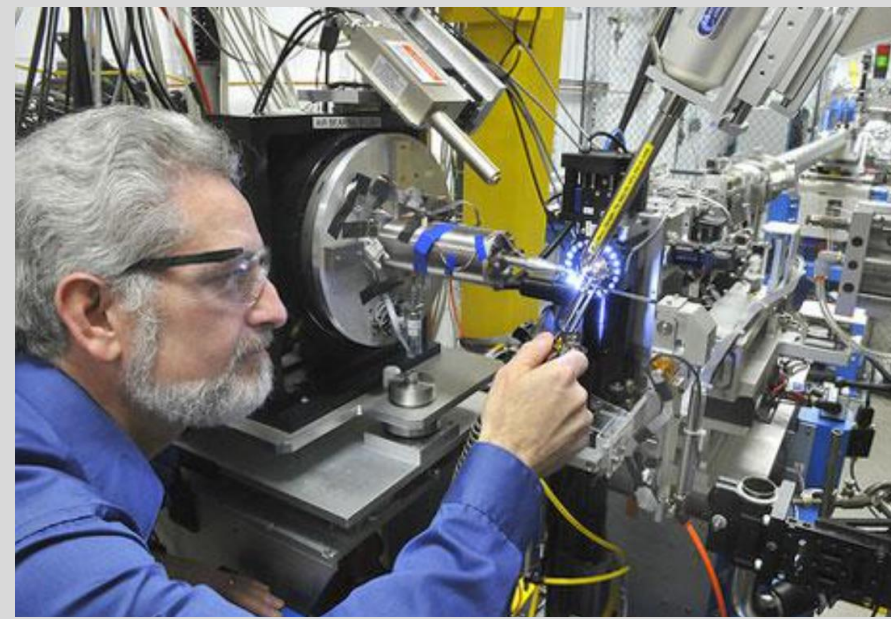

Source Internet

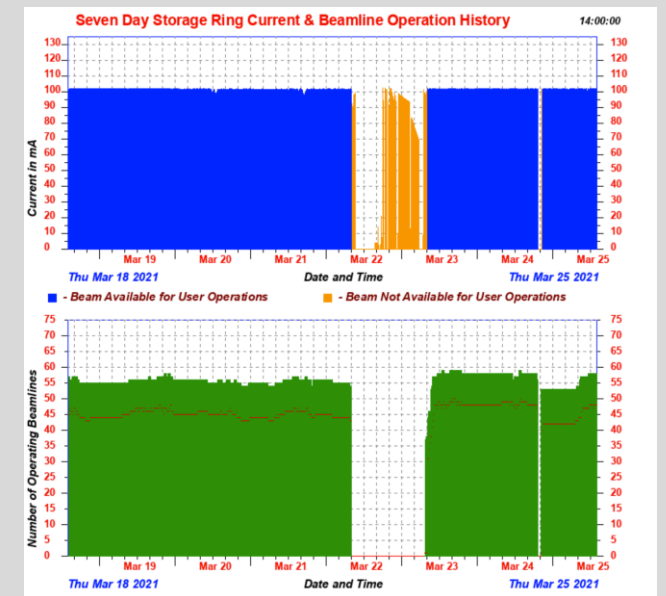
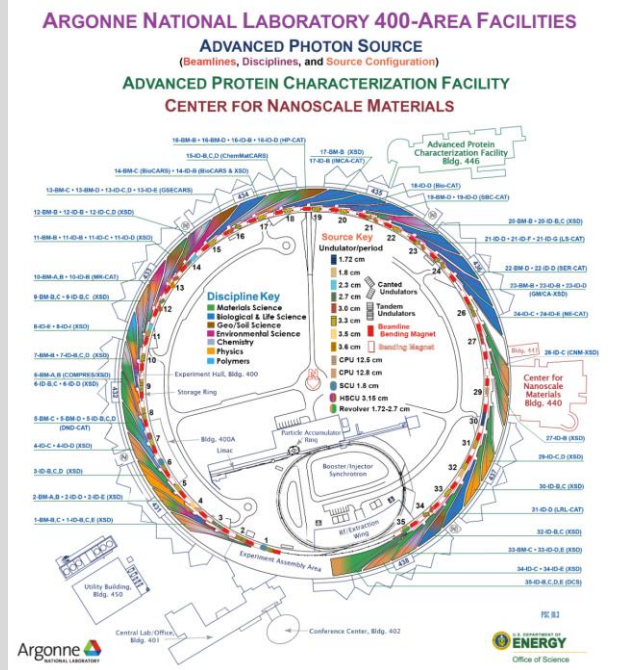

April 14, 2021

Richard Feynman

“Whenever you see a **sweeping statement** that a tremendous amount can come from a very small number of assumptions,
You always find that it is False

There are usually a large number of
Implied Assumptions
that are far from obvious if you think about them sufficiently carefully.”

Section 26-1.

The Feynman Lectures on Physics, Mainly Electromagnetism and Matter 1963 also at http://www.feynmanlectures.caltech.edu/II_toc.html

CHALLENGE TO THE AUDIENCE

Find and Discuss the Implied Assumptions in this Talk

Contact me at Bob.Eisenberg@gmail.com

Maxwell's Core Equations are Universal and Exact

But they are **Complicated Differential Equations**

need very complicated mathematics to describe **universal** physics

Electro 'statics'

$$\nabla \cdot \mathbf{E} = \frac{\rho}{\epsilon_0}$$

Electrodynamics

$$\nabla \times \mathbf{E} = -\frac{\partial \mathbf{B}}{\partial t}$$

Magneto 'statics'

$$\nabla \cdot \mathbf{B} = 0$$

Magnetodynamics

$$\nabla \times \mathbf{B} = \mu_0 \left(\mathbf{J} + \epsilon_0 \frac{\partial \mathbf{E}}{\partial t} \right)$$

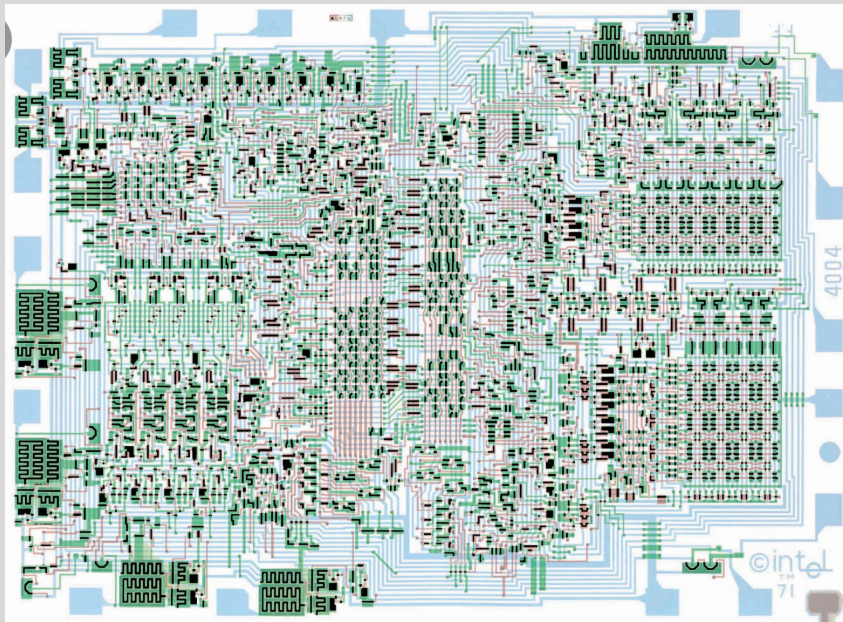

Integrated Circuit

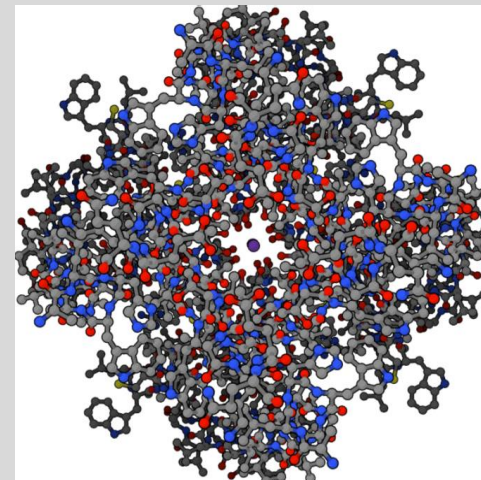

Potassium Ion Channel $K_{v1.2}$
PDB: 1BL8

or

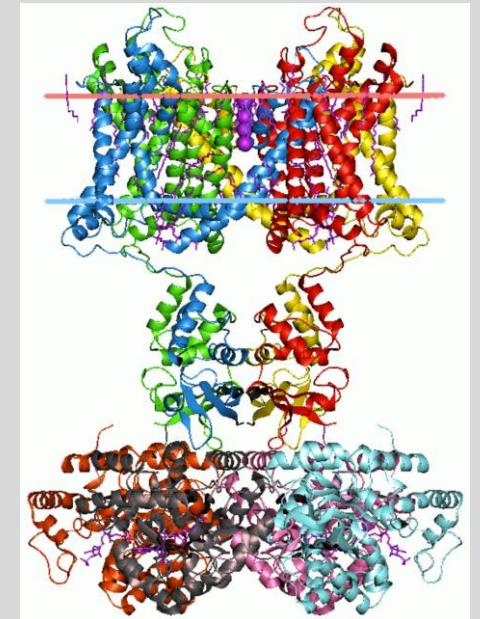

Don't Recognize these Maxwell Equations?

“ ... if we exhibit in every case all the charges, whatever their origin, the equations are always correct ...
The fundamental equations for \mathbf{E} ... represent our deepest and most complete understanding of electrostatics.”

Section 10-4 Feynman, Leighton, and Sands (1963) *The Feynman: Lectures on Physics, Vol. 2 Mainly Electromagnetism and Matter.*

http://www.feynmanlectures.caltech.edu/II_toc.html

$$\mathbf{div} \mathbf{E} = \frac{\rho}{\epsilon_0}$$

$$\mathbf{div} \mathbf{B} = 0$$

$$\mathbf{curl} \mathbf{E} = -\frac{\partial \mathbf{B}}{\partial t}$$

$$\mathbf{curl} \mathbf{B} = \mu_0 \left(\mathbf{J} + \epsilon_0 \frac{\partial \mathbf{E}}{\partial t} \right)$$

Relativistic
Property of
Space
NOT matter

\mathbf{E} is electric field, \mathbf{B} is magnetic field

\mathbf{J} is the current of all mass, including brief dielectric transients of the \mathbf{P} and \mathbf{D} fields

ρ is charge density (of all types)

Where is the dielectric constant ϵ_r ?
more later

Corollaries of Maxwell's Core Equations

Derivation of the Continuity Equation

Linking Flux and Content

$$\mathbf{curl} \mathbf{B} = \mu_0 \left(\overbrace{\mathbf{J}(x, t)}^{\text{Flux of All Charges}} + \varepsilon_0 \partial \mathbf{E} / \partial t \right)$$

$$\mathbf{div} \mathbf{curl} \mathbf{B} = 0 = \mu_0 \mathbf{div}(\mathbf{J}(x, t) + \varepsilon_0 \partial \mathbf{E} / \partial t)$$

$$\mathbf{div} \mathbf{J}(x, t) = -\varepsilon_0 \mathbf{div}(\partial \mathbf{E} / \partial t) = -\varepsilon_0 \partial(\mathbf{div} \mathbf{E}) / \partial t$$

$$\text{But } \mathbf{div} \mathbf{E} = \rho / \varepsilon_0$$

$$\mathbf{div} \mathbf{J} = -\partial \rho / \partial t$$

Corollaries of Maxwell's Core Equations

Continuity Equation

Linking Flux and Content

$$\mathbf{div} \mathbf{J} = - \frac{\partial \rho}{\partial t}$$

Question for Students

This is not a useful equation on atomic scale
Why?

Continuity Equation

Linking Flux and Content

Feynman's Hidden Implications

$$\text{div } \mathbf{J} = - \frac{\partial \rho(x, y, z|t)}{\partial t}$$

Oh Dear!
Often impossible

Must know all charges $\rho(x, y, z|t)$

at all times

Continuity Equation

Feynman's Hidden Implications

Must know all charges and how they move

$$\text{div } \mathbf{J} = - \frac{\partial \rho(x, y, z | t)}{\partial t}$$

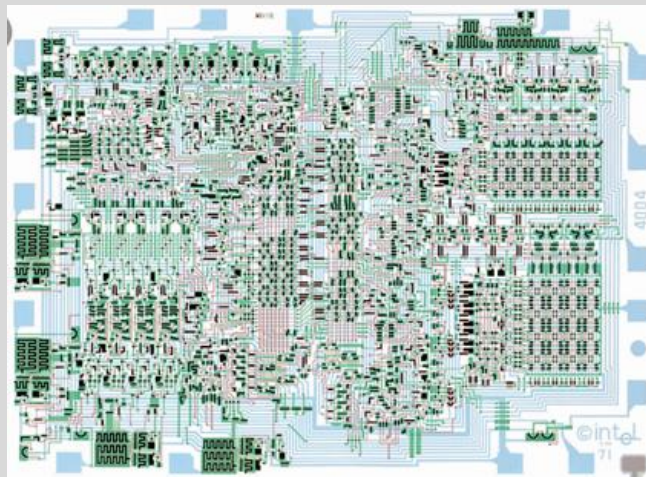

Integrated Circuit

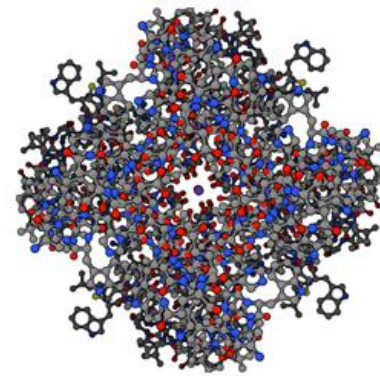

Potassium Ion Channel $K_{V1.2}$

PDB: 1BL8

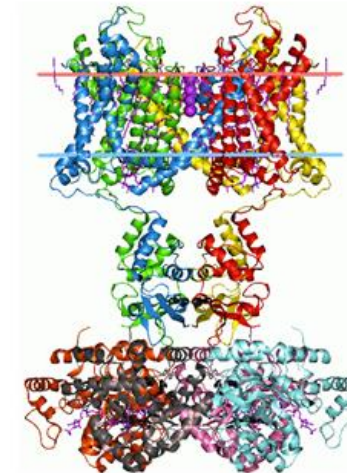

Hopeless, if one must

**“... exhibit in every case all the charges,
whatever their origin”
at all times**

Section 10-4 of Feynman, Leighton, and Sands (1963) vol. 2 *Electromagnetism and Matter*

Without Conservation of Current
Need to Know ALL charges at all times!!

*Hopeless in large systems
where all ions interact with each other!*

integrated circuit

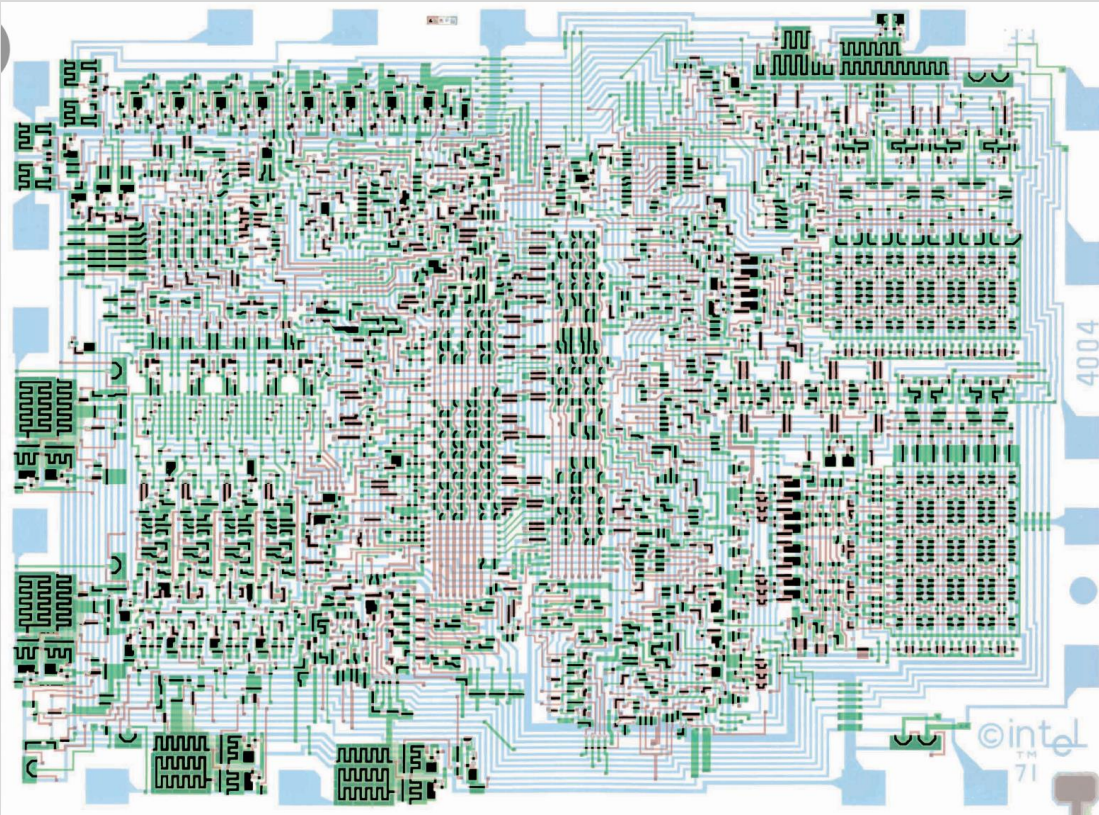

Source: textbooks and internet

Seems Hopeless

***Fortunately,
it is not hopeless***

Stay Tuned

Kirchhoff's Current Law Brings hope

It is NOT necessary in computers to know all the charges!

Kirchhoff's Current law is (almost) enough

Corollaries of Maxwell Equations

Conservation of Current

Linking Current and Electric Field

$$\text{curl } \mathbf{B} = \mu_0 (\mathbf{J} + \epsilon_0 \partial \mathbf{E} / \partial t)$$

$$\text{div curl } \mathbf{B} = \mathbf{0} = \mu_0 \text{div}(\underbrace{\mathbf{J} + \epsilon_0 \partial \mathbf{E} / \partial t}_{\text{Total Current} = \mathbf{J}_{\text{total}}})$$

Total Current = $\mathbf{J}_{\text{total}}$

$$\boxed{\text{div } \mathbf{J}_{\text{total}} = 0}$$

\mathbf{J} = Flux of All Charges with mass, however small or transient

Corollaries of Maxwell Equations

Conservation of Total Current

$$\text{div } \mathbf{J}_{\text{total}} = 0$$

Notice: there are ZERO adjustable or vaguely defined parameters
 \mathbf{J} , \mathbf{E} , $\mathbf{J}_{\text{total}}$ are routinely measured in laboratories

Scary



Scientists are Taught to be Skeptical

Particularly of Universal Exact Theories
as they should be!





Richard Feynman

“Whenever you see a **sweeping statement** that a tremendous amount can come from a very **small number of assumptions**,
You always find that it is False.

There are usually a large number of
Implied Assumptions
that are far from obvious if you think about them sufficiently carefully.”

Section 26-1.

The Feynman Lectures on Physics Vol 2 (1963) also at http://www.feynmanlectures.caltech.edu/II_toc.html





Challenge to Audience

What are implied assumptions?

in Conservation of Total Current and Core Maxwell Equations

Contact Bob.Eisenberg@gmail.com



Challenge to Audience

What are implied assumptions?

Hint:

Look at usual formulation of Maxwell Equations

*Textbook formulation of Maxwell Equations Depends on **Dielectric Properties***

$$\mathbf{div} \mathbf{D} = \mathbf{div} \boldsymbol{\epsilon}_r \epsilon_0 \mathbf{E} = \rho_f$$

$$\frac{1}{\mu_0} \mathbf{curl} \mathbf{B} = \tilde{\mathbf{J}} + \boldsymbol{\epsilon}_r \epsilon_0 \frac{\partial \mathbf{E}}{\partial t}$$

Relativistic Property
of
Space
NOT matter

Bold red means dangerously oversimplified: $\mathbf{D}, \tilde{\mathbf{J}}, \boldsymbol{\epsilon}_r, \rho_f$

What is a Dielectric?

What is Polarization?

Mechanical Systems need model
of how force changes mass distribution

Stress Strain Relation is needed in mechanics

Hooke's law or its time dependent and nonlinear generalizations

Electrical Systems need model of how electrical force changes charge distribution

Polarization is Stress Strain of Charge

Model of dielectric and its time dependent and nonlinear generalizations

Mechanical Systems need Model of how Force changes Mass distribution

STRESS STAIN RELATION is needed in models of mechanics

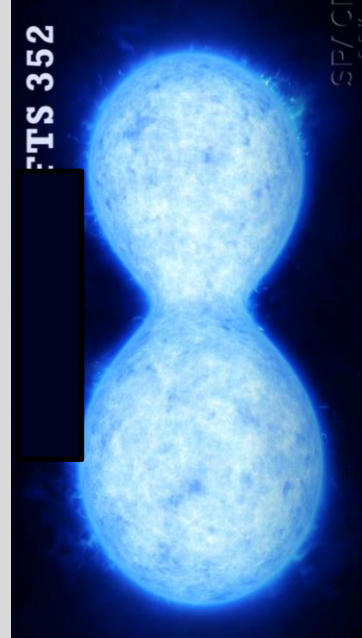

Gravitational Field Distorts Shape of Stars
Double Star VFTS 352

Source Internet

Electric Force Moves Charge so Electric Force Changes ρ Polarization is Stress Strain of Charge

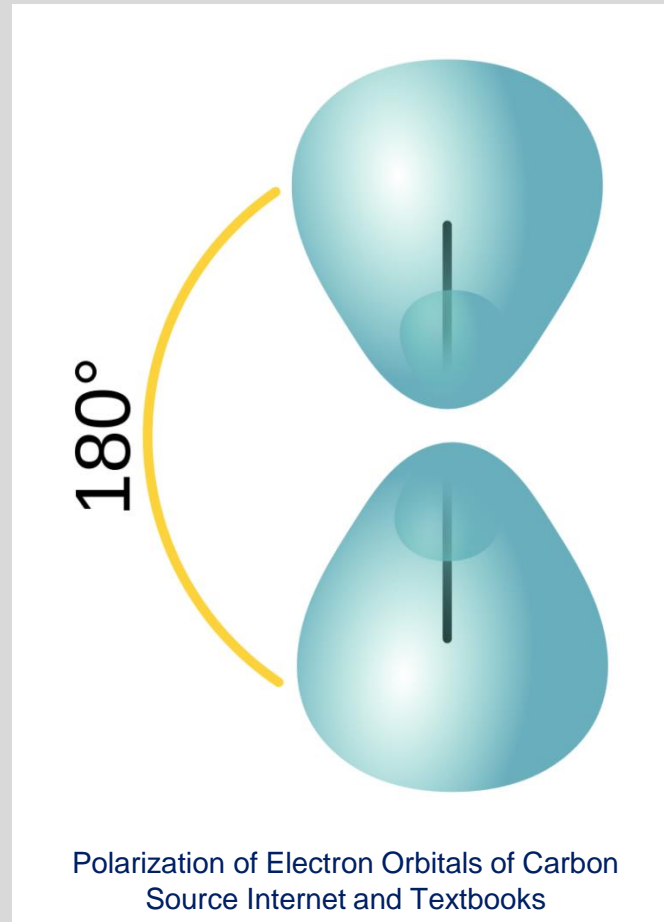

**Polarization is almost never ideal
It always depends strongly on time
It often depends on the electric field**

Source Internet

Polarization

is the Electrical Analog of the STRESS STRAIN relationship of Mechanics

**Polarization is the change in Charge Distribution
when Electric Force changes**

**Polarization depends on time
because charge takes time to move**

Polarization cannot be described by a dielectric constant independent of time

Dielectric Model does not fit data

L.F. Lima et al. / Journal of Molecular Liquids 241 (2017) 530–539

53

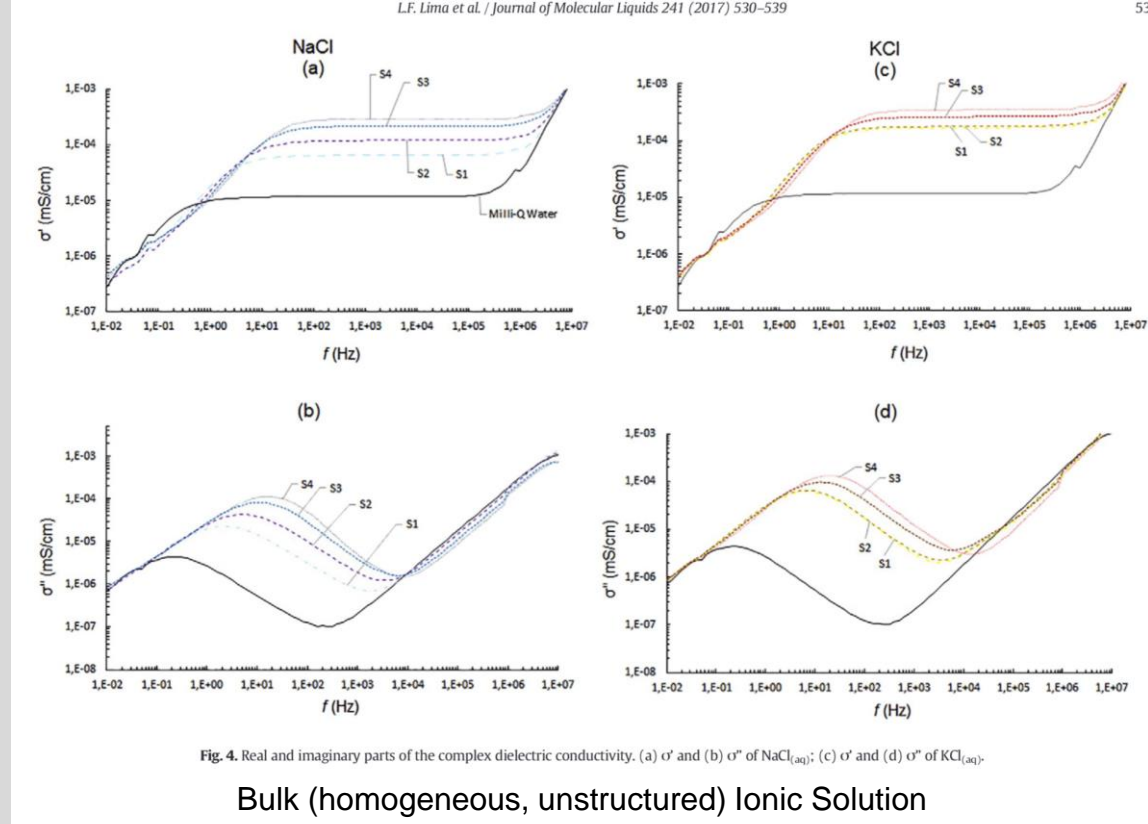

**Electrical Systems need Models
of how electrical force changes charge distribution**

Electrical Systems need Model of How Electrical Force changes Charge Distribution

Dielectric Model does not fit data from Proteins

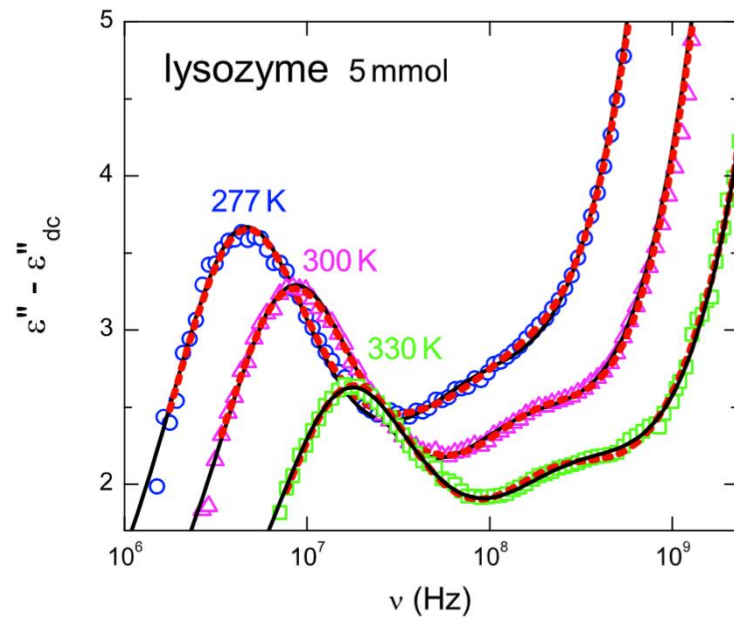
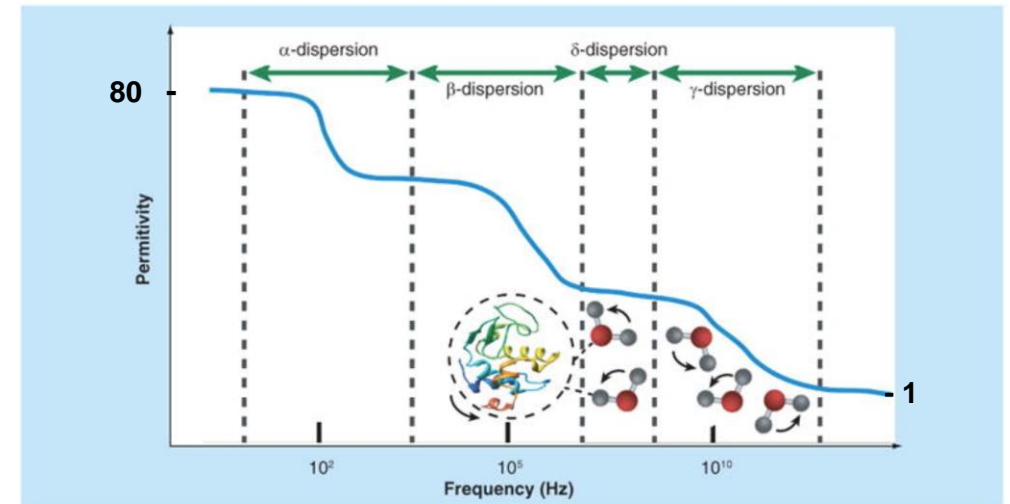

Fig. 3. Dielectric-loss spectra of a 5 mmol lysozyme solution in the region of the β - and δ -relaxations at different temperatures. The solid lines are fits using the sum of a Debye function for the β -relaxation and two Cole-Cole functions for the δ - and γ -relaxations. Dashed lines represent fits with four Debye functions according to Ref. [4].

Wolf, Gulich, Lunkenheimer & Loidl. 2012.
Biochimica et Biophysica Acta (BBA) –
Proteins and Proteomics 1824:723-730.



Complex permittivity spectrum of a typical protein solution showing distinct dispersions at their respective frequency range

as Feynman hints

Move the physics of dielectrics into \mathbf{J} and ρ to make **Maxwell's Core Equations**

$$\mathbf{div} \mathbf{E} = \frac{\rho}{\epsilon_0} \qquad \mathbf{div} \mathbf{D} = \mathbf{div} \overbrace{\epsilon_r \epsilon_0 \mathbf{E}} = \rho_f$$

$$\frac{1}{\mu_0} \mathbf{curl} \mathbf{B} = \mathbf{J} + \epsilon_0 \frac{\partial \mathbf{E}}{\partial t} \qquad \frac{1}{\mu_0} \mathbf{curl} \mathbf{B} = \tilde{\mathbf{J}} + \epsilon_r \epsilon_0 \frac{\partial \mathbf{E}}{\partial t}$$

Polarization is part of \mathbf{J} and ρ

When nothing is known about polarization, it is customary and appropriate to include the dielectric constant ϵ_r as a single real positive constant $\epsilon_r \geq 1$

Maxwell's Core Equations

Describe Electricity with no errors, $<10^{-6}$

in any technological situation

$$\operatorname{div} \mathbf{E} = \frac{\rho}{\epsilon_0}$$

$$\operatorname{div} \mathbf{B} = 0$$

$$\operatorname{curl} \mathbf{E} = -\frac{\partial \mathbf{B}}{\partial t}$$

$$\operatorname{curl} \mathbf{B} = \mu_0 \left(\mathbf{J} + \epsilon_0 \frac{\partial \mathbf{E}}{\partial t} \right)$$

Relativistic
Property of
Space
NOT matter

Implicit Assumptions are ONLY in ρ

NO Implicit Assumptions in Conservation of Total Current

$$\text{div } \mathbf{J}_{\text{total}} = 0$$

$$\text{div } (\mathbf{J} + \epsilon_0 \partial \mathbf{E} / \partial t) = 0$$

**Flux of all charge
with mass**

**Relativistic
Property of
Space
NOT matter**

ρ does not appear

No adjustable parameters

\mathbf{J} and \mathbf{E} and $\mathbf{J}_{\text{total}}$ are routinely measured in laboratories!!!

Conservation of Total Current

$$\text{div } \mathbf{J}_{\text{total}} = 0$$

ρ does not appear

No adjustable parameters

\mathbf{J} and \mathbf{E} and $\mathbf{J}_{\text{total}}$ are routinely measured in laboratories!!!

Scary: nothing to Adjust

No implicit parameters or assumptions are visible

Audience:

Can you find any? Contact Bob.Eisenberg@gmail.com

Scary

Nothing to Adjust

Scientists are Taught to be Skeptical

Particularly of Universal Exact Theories

as they should be

but

Conservation of Total Current

appears to be

Universal and Exact

Independent of all properties of matter and charge

Conservation of Total Current is NOT a theory of everything

Conservation only describes
Total Current J_{total}

When flux J of charge is important, conservation of current is not enough

$$\text{div} \left(\underbrace{J + \epsilon_0 \frac{\partial E}{\partial t}}_{\text{Total Current } J_{total}} \right) = 0$$

$$\Rightarrow \text{div } J \neq 0$$

Conservation only describes **Total Current** J_{total}

When flux J of charge or charge movement is important,
conservation of current is not enough

$$\mathbf{div} \left(\mathbf{J} + \epsilon_0 \frac{\partial \mathbf{E}}{\partial t} \right) = 0 \quad \Rightarrow \quad \mathbf{div} \mathbf{J} \neq \mathbf{0}$$

$$\mathbf{div} \mathbf{J} = - \mathbf{div} \left(\epsilon_0 \frac{\partial \mathbf{E}}{\partial t} \right) \neq \mathbf{0}$$

Flux J of charged matter is NOT NOT NOT conserved

$$\text{div} \left(\mathbf{J} + \epsilon_0 \frac{\partial \mathbf{E}}{\partial t} \right) = 0 \quad \Rightarrow \quad \text{div} \mathbf{J} \neq 0$$

Maxwell core Equations imply that
Charge and Matter accumulate because $\epsilon_0 \frac{\partial \mathbf{E}}{\partial t} \neq 0$

$$\text{div} \mathbf{J} = -\epsilon_0 \frac{\partial \mathbf{E}}{\partial t} \neq 0$$

Relativistic
Property of
Space
NOT matter

***In physical language of electronics,
Some charge accumulates in the 'stray capacitance'
of space
independent of matter***

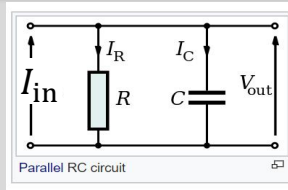

$$V_{out} = I_{in} (1 - e^{-t/RC})$$

In language of electronics
Flux of electrons into a Resistor does NOT equal Flux of electrons out of Resistor

Total Current I_1 into a Resistor DOES EQUAL the Total Current I_2 out of a Resistor

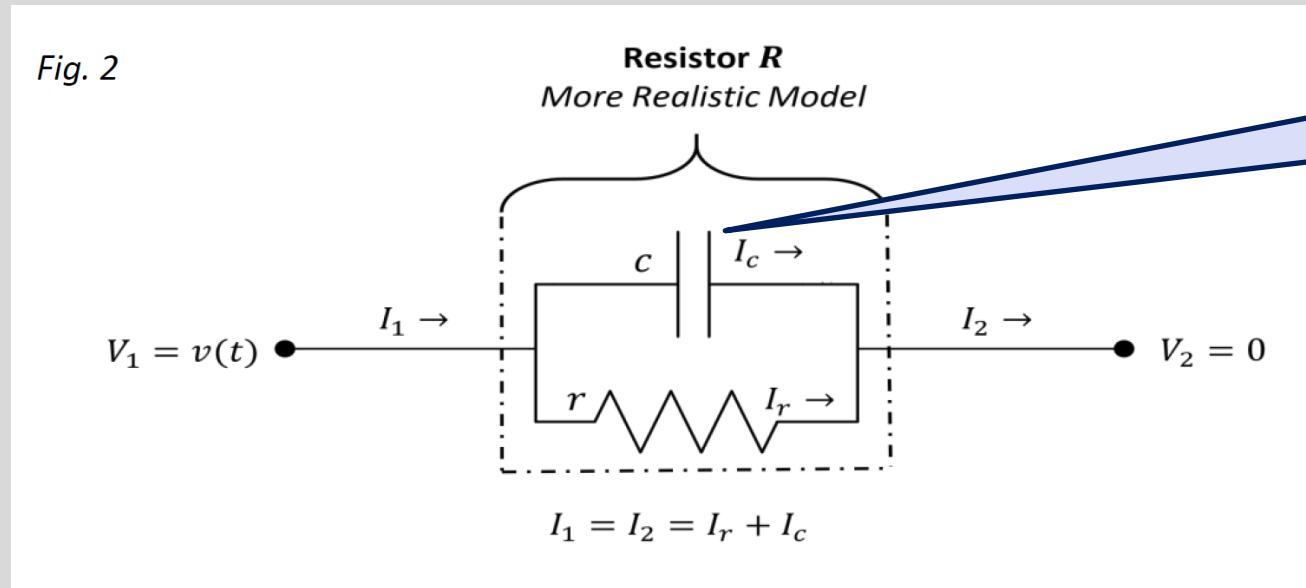

Includes
Relativistic
Property of
Space
NOT matter

Eisenberg, B., N. Gold, Z. Song, and H. Huang. 2018. What Current Flows Through a Resistor? arXiv preprint arXiv:1805.04814.
Eisenberg, R. S. 2019. Kirchoff's Law can be Exact. arXiv preprint available at <https://arxiv.org/abs/1905.13574>.

Electromagnetic Field Exists in Vacuum

where $\rho = 0$ and $\mathbf{J} = 0$ and $c =$ velocity of light
because of the relativistic properties space

$$\text{div } \mathbf{E} = 0$$

$$\text{div } \mathbf{B} = 0$$

$$\text{curl } \mathbf{E} = -\frac{\partial \mathbf{B}}{\partial t}$$

$$\text{curl } \mathbf{B} = \underbrace{\mu_0 \varepsilon_0 \frac{\partial \mathbf{E}}{\partial t}}_{\text{Ethereal Current}} = c^{-2} \frac{\partial \mathbf{E}}{\partial t}$$

Ethereal Current = Displacement Current

Relativistic
Property of
Space
NOT matter

Relativistic
Property of
Space
NOT matter

Derivation of Wave Equation is in every textbook, starting with $\text{curl curl } \mathbf{E}$

Light travels through the Vacuum of Space

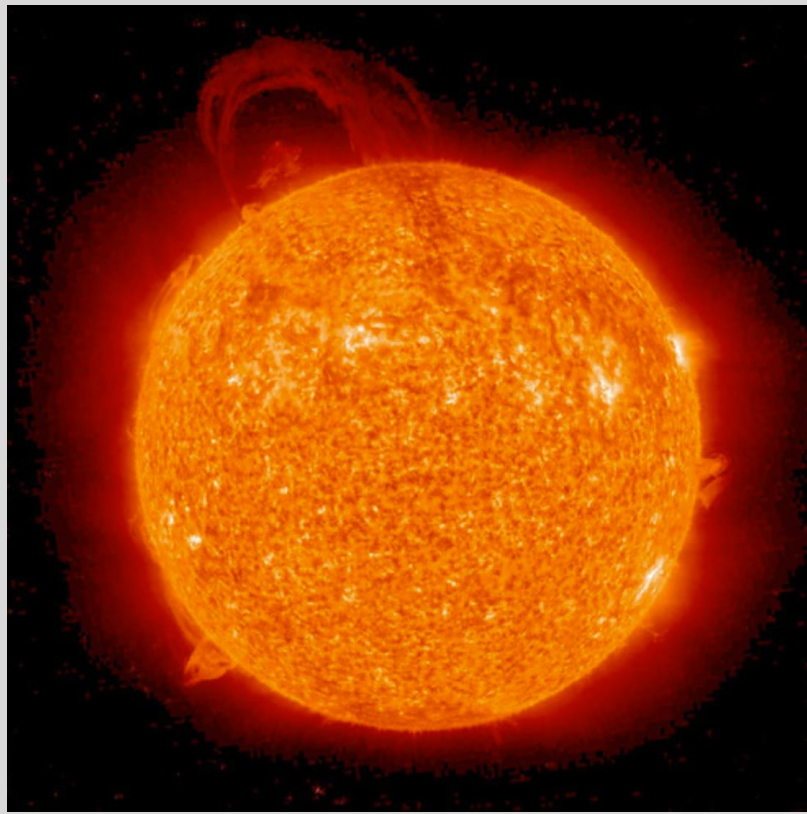

The Sun
with Prominence

Source Internet



Galaxy

April 14, 2021

Conservation of Total Current J_{total}

is

**Universal and Exact
because**

It is a Property of Space

$\partial E / \partial t$ in a perfect vacuum produces B field

Not a property of matter

It arises from the Principle of Relativity

every textbook and

Dunstan, D. (2008) Phil Trans Roy Soc A: 366 1861

**Charge does not vary when velocity \rightarrow speed of light
Length, time, and (relativistic) Mass, do vary**

Conservation of Total Current J_{total}

is a

An example of
Feynman's
Hidden Factor

Property of Space

not matter

That is why it is Universal and Exact

Well known Example

Taught,
or should be taught,
In First Year of Physics

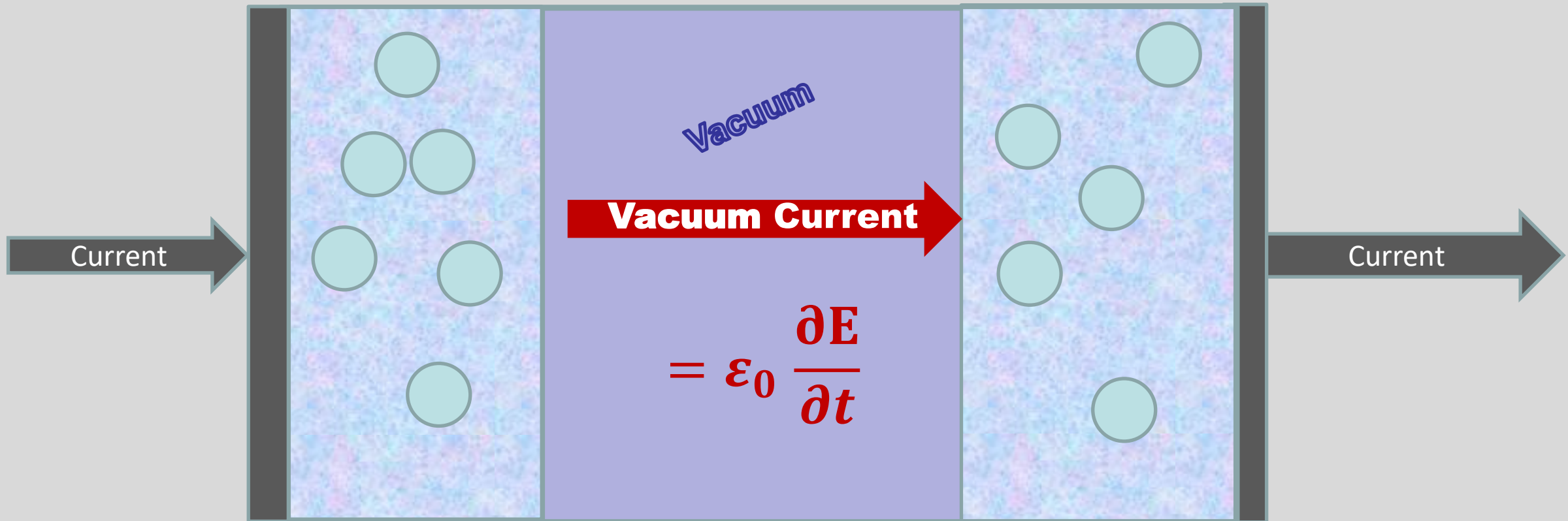

Vacuum current = Ethereal current = Displacement Current
All are names for the same thing $\epsilon_0 \partial E / \partial t$

Conservation of Current is Exact and Universal

So what?

Total Current J_{total} must always be described by Continuum Equations

Particle motion J itself does NOT define Current J_{total}

Contradicts Intuition

Current $J_{\text{total}} \neq$ Flux of charge J

Flux J is defined by only particle motion

Total Current J_{total} is not defined by particle motion alone

**Not Widely Known
In Biophysics**

**Contradicts Intuition
Small Systems**

REQUIRE

Continuum Description

of

Electric Current

Total Current J_{total} does NOT flow by hopping

Current is independent of location in series systems

Particle Motion can be hopping, not current

Well known In Electronics

“Hopping Models Ignore Capacitive Currents”

Paraphrase from Landauer (1992)

Conductance from transmission: common sense points.

Physica Scripta 1992 p.110

Paradigm Change

Eisenberg, B., N. Gold, Z. Song, and H. Huang. 2018. What Current Flows Through a Resistor? arXiv preprint arXiv:1805.04814.

Eisenberg, R. S. 2019. Kirchhoff's Law can be Exact. arXiv preprint available at <https://arxiv.org/abs/1905.13574>.

Contradicts Intuition

Small Systems

REQUIRE

Continuum Description

Total Current J_{total} does NOT flow by hopping

Current J_{total} is independent of location in series systems

Particle Motion J can be hopping, not total current J_{total}

Well known In Electronics

“Hopping Models Ignore Capacitive Currents”

Paraphrase from Landauer (1992)

Conductance from transmission: common sense points.

Physica Scripta 1992 p.110

Conservation of Total Current J_{total}
is
EQUALITY of Total Current in a Channel
or
Series System

Well known in Electronics

“It is, after all, the **sum** of electron current and **displacement** current
which has **no divergence**.
One of those two components can take over from the other.”

Landauer (1992) Physica Scripta T42 p 110.

“**Electrodynamic** fields are endowed by **unique** features,
including an **exquisite spatial nonlocality**”

Slight paraphrase of Lundeberg *et al* (2017)
Tuning quantum nonlocal effects plasmonics
Science 357:187-191

Flux and Total Current J_{total} have very Different Physics in Different Systems

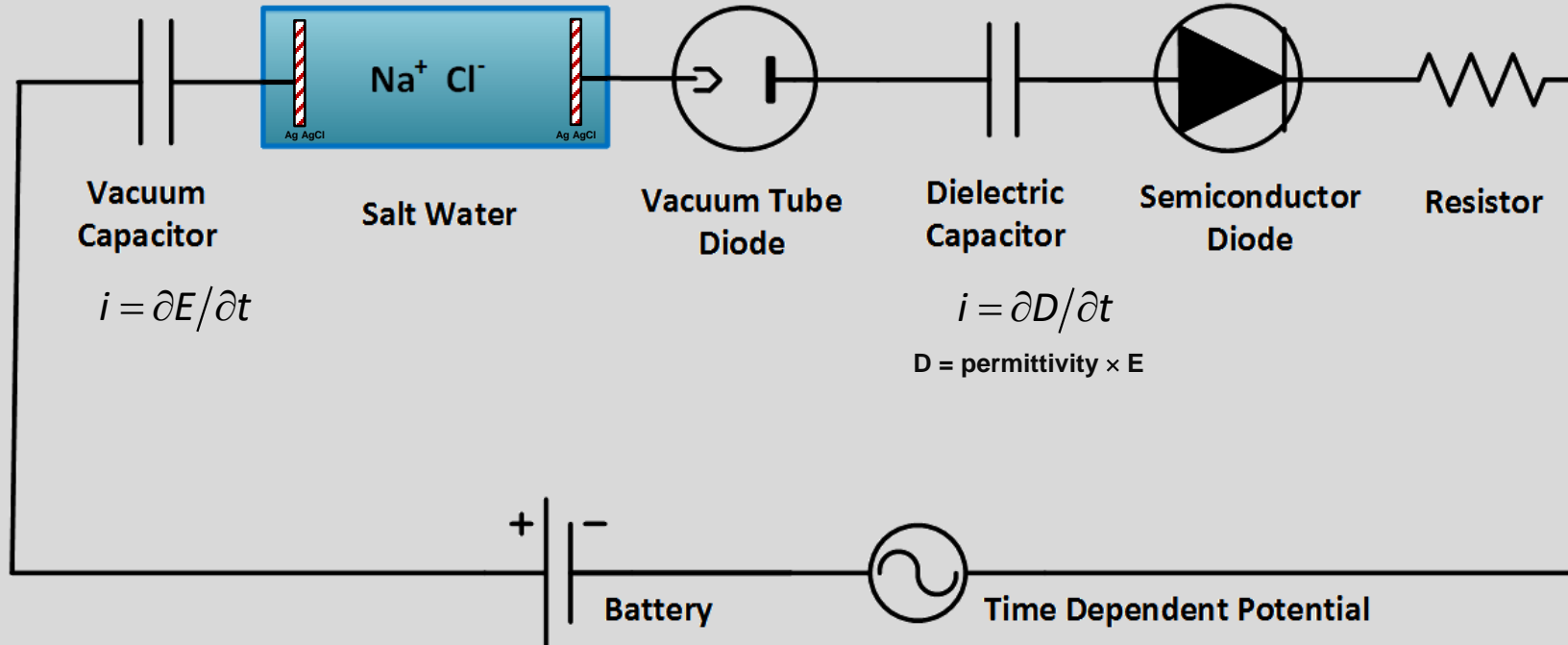

but

Continuity of Total Current J_{total} is Exact

$$J_{\text{total}} \text{ in Device 1} = J_{\text{total}} \text{ in Device 2} = J_{\text{total}} \text{ in Device 3} \dots$$

*no matter what carries the current J
at all times and all locations!*

Conservation of Total Current J_{total} is Exact

**even though
Physics of Charge Flow
Varies Profoundly**

How can that possibly be?

Electrodynamic Fields \mathbf{E} , \mathbf{B} take on the
Values that Conserves total Current J_{total}
This is NOT mysterious
E is the force field that moves atoms

so total current $\mathbf{J}(x, t) + \epsilon_0 \partial \mathbf{E} / \partial t$ is always conserved

Details and PROOF
including quantum mechanics at
*Eisenberg, Oriols, and Ferry. 2017. Dynamics of Current, Charge, and Mass.
Molecular Based Mathematical Biology 5:78-115
and arXiv <https://arxiv.org/abs/1708.07400>*

**E is a force field that moves atoms
because atoms have charge**

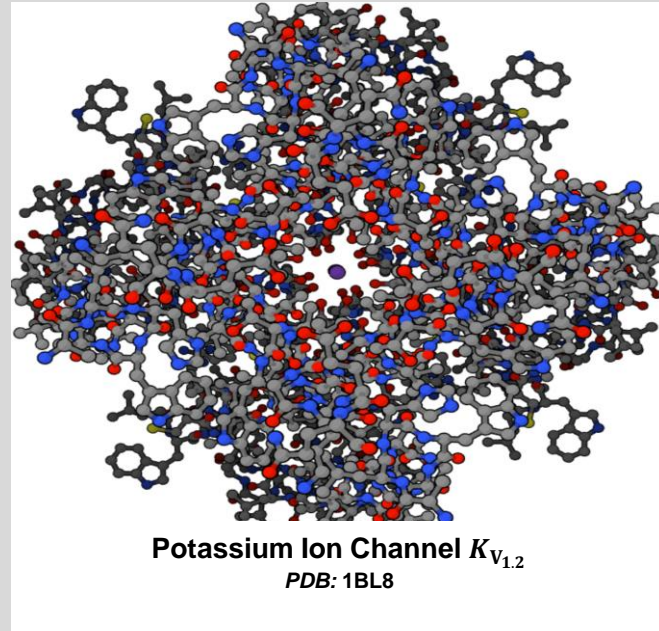

so total current $\mathbf{J}_{total} = \mathbf{J}(x, t) + \epsilon_0 \partial \mathbf{E} / \partial t$ is always conserved

Details and PROOF
including quantum mechanics at
*Eisenberg, Oriols, and Ferry. 2017. Dynamics of Current, Charge, and Mass.
Molecular Based Mathematical Biology 5:78-115
and arXiv <https://arxiv.org/abs/1708.07400>*

**EQUALITY of Total Current J_{total}
is
an Enormous Simplification**

**Eisenberg, B., N. Gold, Z. Song, and H. Huang. 2018. What Current Flows Through a Resistor?
arXiv preprint <https://arxiv.org/abs/1805.04814>.**

**Eisenberg, R. S. 2019. Kirchhoff's Law can be Exact. arXiv preprint available at
<https://arxiv.org/abs/1905.13574>.**

Current flow is very smooth in spatial coordinate

Differential equation in x is not needed for J_{total}

$$J_{total} = J + \epsilon_0 \partial E / \partial t$$

What does this mean for theory and simulations?

Opportunity to Simplify Algorithms and Codes
perhaps dramatically

Spatial Dependence is Already Known

Only have to average the time dependence

Ma, Li and Liu (2016). arXiv:1605.04886; Ma, Li and Liu (2016). arXiv:1606.03625.

Current flow is very smooth in spatial coordinate
Differential equation in x is not needed for $J_{total} = J + \epsilon_0 \partial E / \partial t$

What does this mean for theory and simulations?

Opportunity to Simplify Algorithms and Codes
perhaps dramatically

Spatial Dependence is Already Known
Only have to average the time dependence
Ma, Li and Liu (2016). arXiv:1605.04886; Ma, Li and Liu (2016). arXiv:1606.03625.

Current Noise J_{total} is Zero in Space

Current Noise
 J_{total}
is
HUGE in time

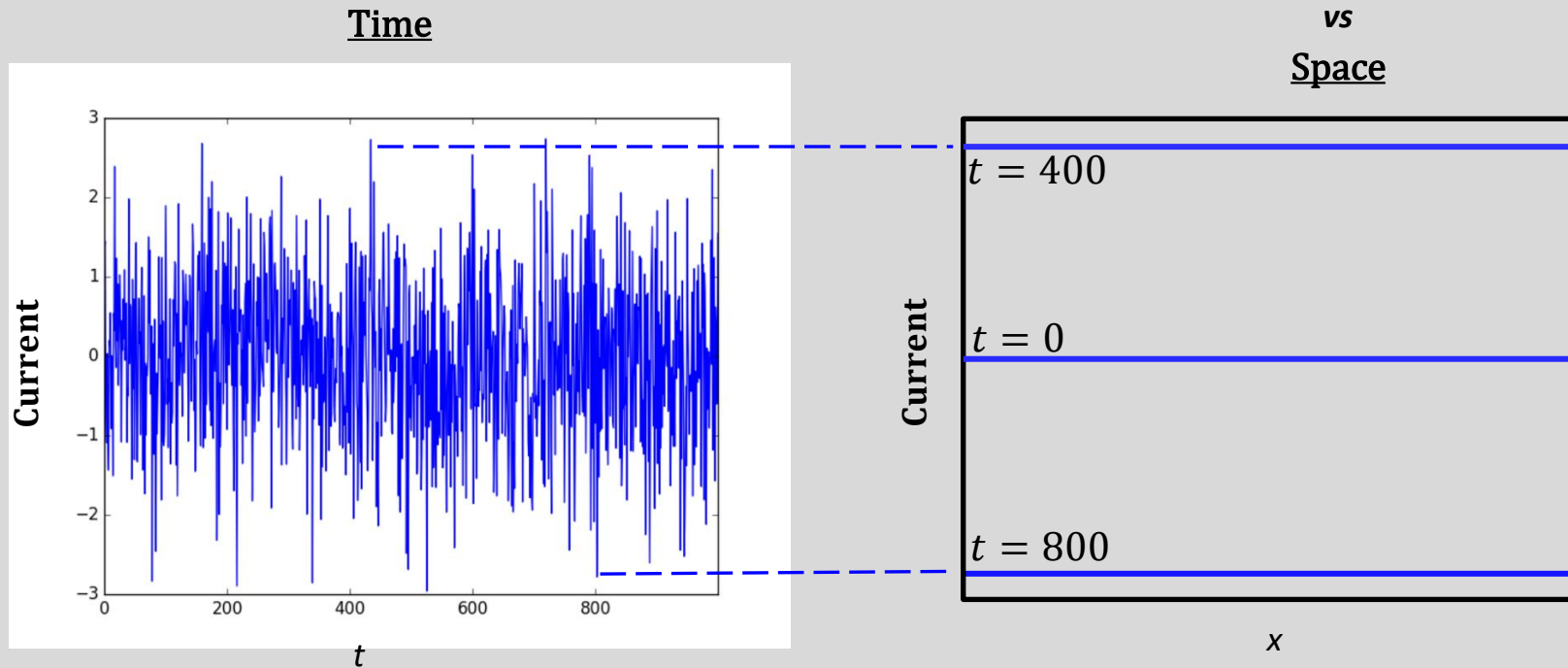

One Dimensional Systems like Channels or Circuit Components

**EQUALITY of Total Current J_{total}
is
an Enormous Simplification**

**It can create a *Perfect Low Pass Filter*
It can *Convert*
Chaos of Brownian Motion
into a *Constant***

What does this mean for Mathematical Models?

The image of total current flow J_{total} is very
different
VERY SMOOTH in space

Total Current J_{total} does not vary in space so
Spatial Derivatives are not needed to
describe total current

But they are needed to describe everything else.

Revolution in Biophysics

**Total Current flow J_{total} is equal everywhere
in a one dimensional channel**

**Thermal Motion in Space does not appear in
equations for flow of total current J_{total} in a
one dimensional channel**

Thermal motion appears ONLY in time

Eisenberg (2020)

Electrodynamics Correlates Knock-on and Knock-off: Current is Spatially Uniform in Ion Channels.

Preprint on arXiv at <https://arxiv.org/abs/2002.09012>.

What does this mean for Ion Channels?

**Knock On and Knock Off of Ions
is**

IRRELEVANT for the Total Current J_{total} Through the Channel

Paradigm Change

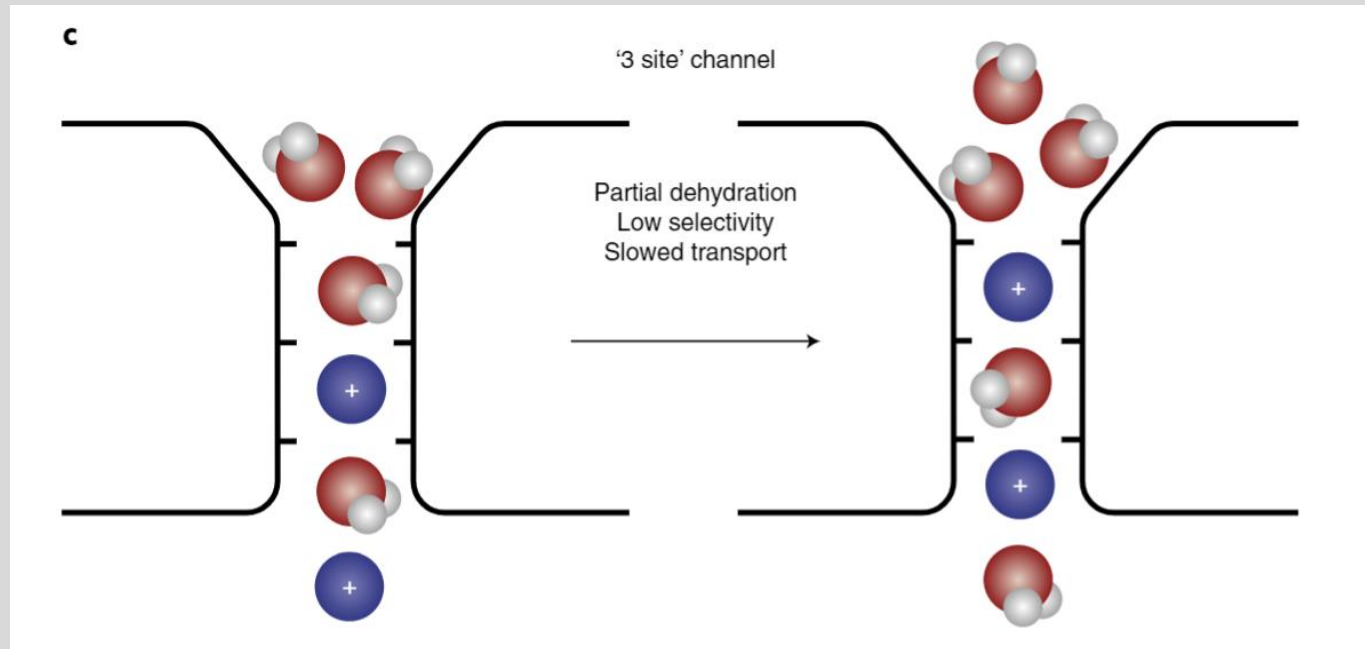

Corry (2018) The naked truth about K^+ selectivity. Nature Chemistry 10:799-800.

Eisenberg (2020)
Electrodynamics Correlates Knock-on and
Knock-off: Current is Spatially Uniform in
Ion Channels.
Preprint on arXiv at
<https://arxiv.org/abs/2002.09012>.

View of Channels has been focused on movements of individual ions
in channels,

But

Total Current J_{total} is equal everywhere
in a one dimensional channel

Paradigm Change

Position does not appear in equations for total
current J_{total} in a one dimensional channel

References and Proofs in

Eisenberg (2019) **Kirchhoff's Law can be Exact.** arXiv: 1905.13574

Eisenberg, Gold, Song, and Huang (2018)
What Current Flows Through a Resistor?
arXiv:1805.04814

**Turn from Biophysics to Electricity and Electronics
And then
Back to Biology**

Kirchhoff's Current Law Should be for TOTAL CURRENT

References and Proofs in

Eisenberg (2019) **Kirchhoff's Law can be Exact.** arXiv: 1905.13574

Eisenberg, Gold, Song, and Huang (2018)
What Current Flows Through a Resistor?
arXiv:1805.04814

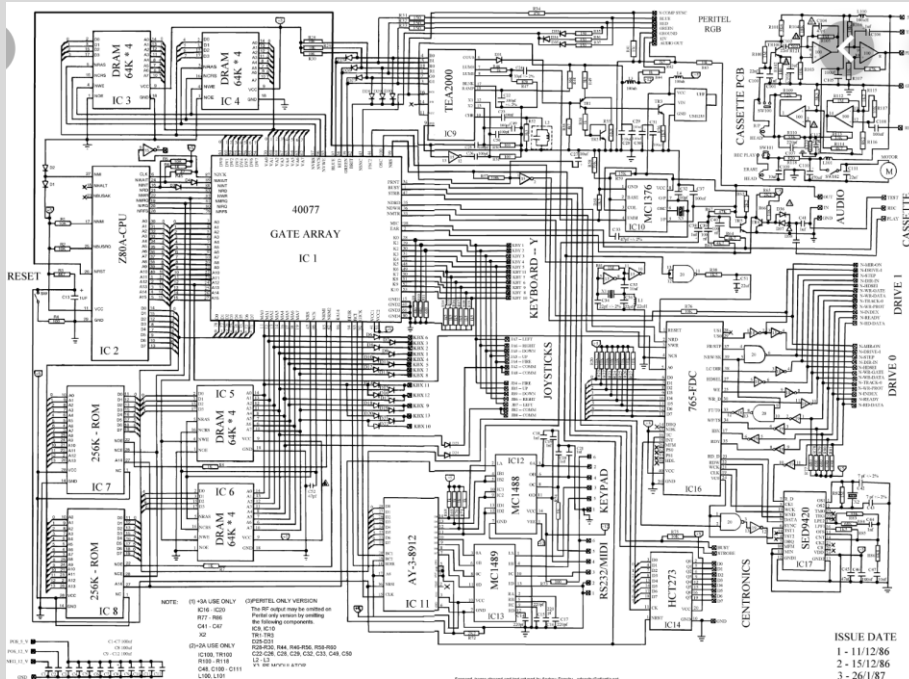

Source: textbooks and internet

It is NOT necessary in our computers to know all the charges! Kirchhoff's law is (almost) enough

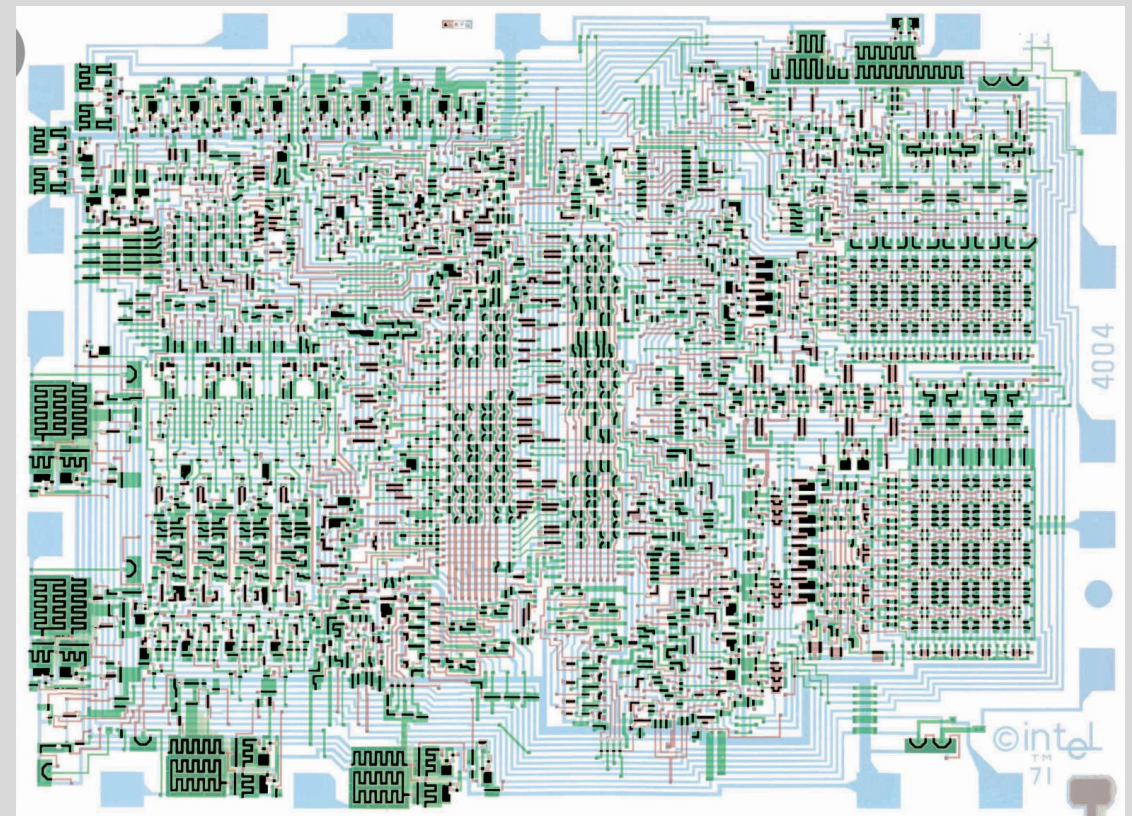

Source: textbooks and internet

Integrated Circuits are Designed
with Kirchhoff's Current Law
and little else!!!

Hard as that is to believe

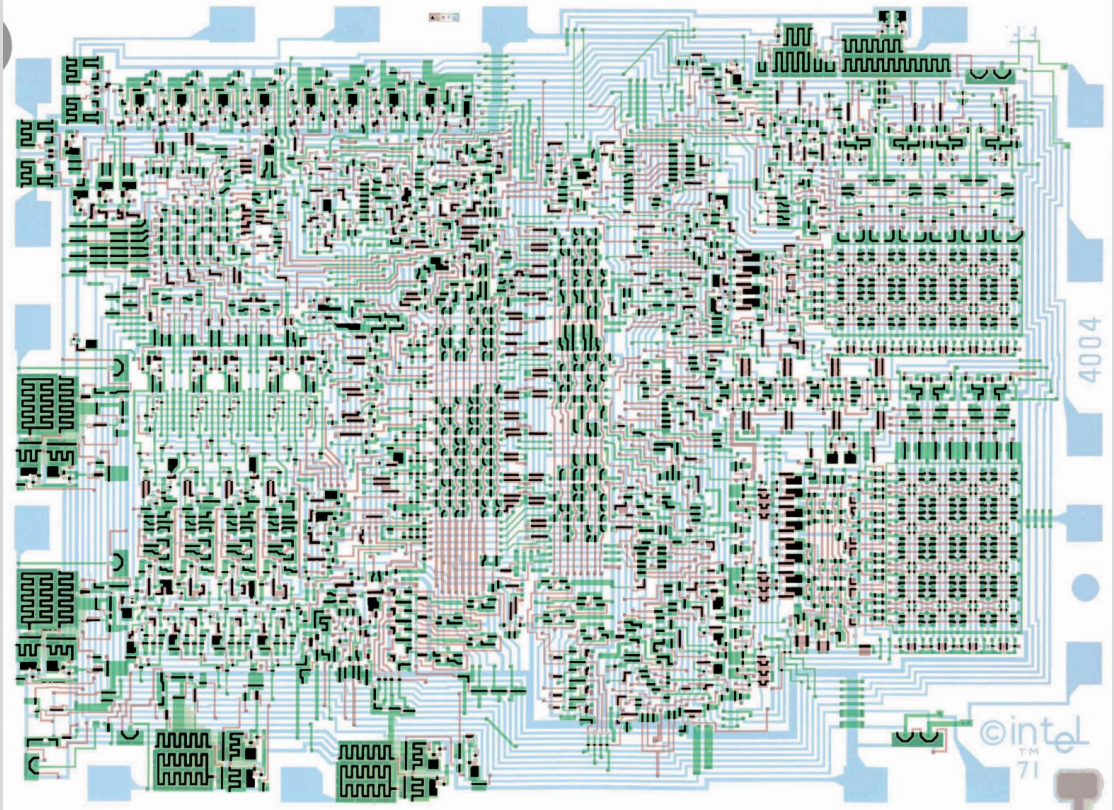
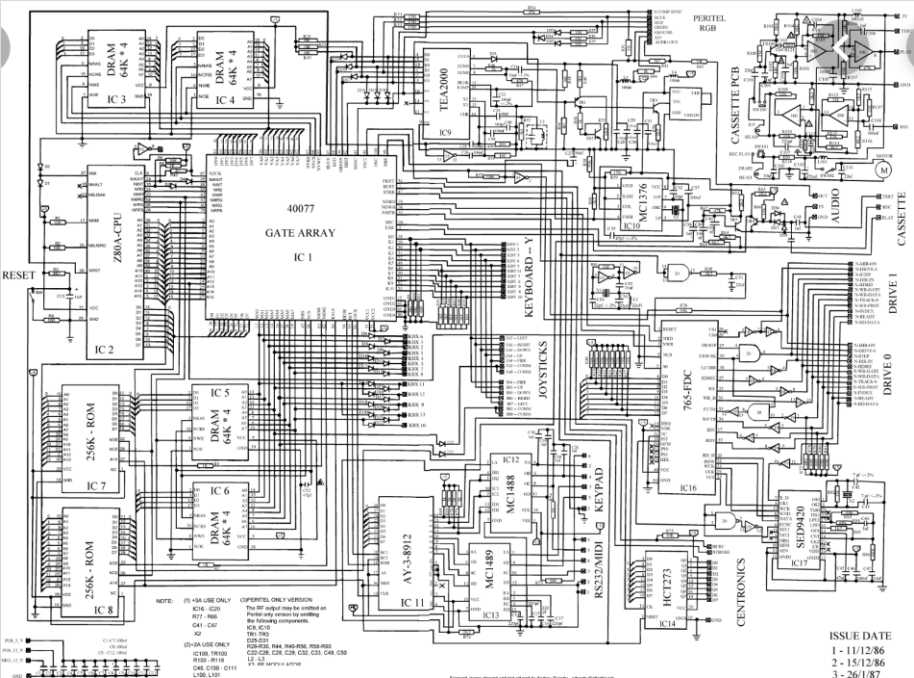

Even at 10^{-10} sec

How can that possibly be?

**Usual Derivation of Kirchhoff's law
is on**

Long Time Scale $\gg 10^{-6}$ sec

NOT AT ALL at 10^{-10} sec

How can that possibly be?

**Usual Derivation of Kirchhoff's law is about
fluxes**

BUT

FLUXES ARE NOT CONSERVED

according to experiment or Maxwell equations

NOT AT ALL at 10^{-10} sec

How can that be?

$$\text{Maxwell } \operatorname{div} J_{total} = 0$$

and

$$\text{Kirchhoff } \operatorname{div} J \neq 0$$

Paradigm Change

DISAGREE

in usual derivation of Kirchhoff
using flux J of charges

How can that possibly be?

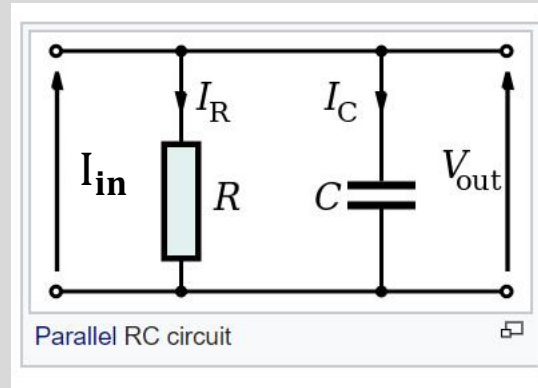

$$V_{out} = I_{in}(1 - e^{-t/RC})$$

$$RC = \text{charging time} = 10^{-12} \text{ farads} \times 10^3 \text{ ohm} = 10^{-9} \text{ sec}$$

FLUXES J ARE NOT CONSERVED

**Kirchhoff's Laws Describe TOTAL CURRENT J_{total}
Not flux J
Valid whenever branched network is valid
And Maxwell's Core Equations are Valid**

References and Proofs in

Eisenberg (2019) **Kirchhoff's Law can be Exact.** arXiv: 1905.13574

Eisenberg, Gold, Song, and Huang (2018)
What Current Flows Through a Resistor?
arXiv:1805.04814

Deriving Kirchhoff's Laws from Maxwell Equations

and conservation of current

is

Trivial if you use Total Current J_{total}

References and Proofs in

Eisenberg (2019) **Kirchhoff's Law can be Exact.**

arXiv: 1905.13574

Eisenberg, Gold, Song, and Huang (2018)

What Current Flows Through a Resistor?

arXiv:1805.04814

All is obvious to a fine practicing engineer and old friend

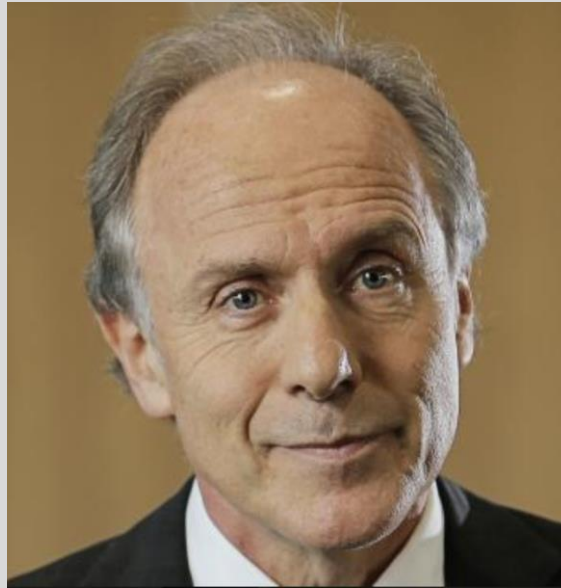

Alan Finkel
Co-designer* of AxoPatch
Amplifier
Founder Axon Instruments,
Recently
Chief Scientist
Australian Government

**“Bob, why do you need all that math?
Everyone knows how to use Kirchhoff.
Everyone knows you have to include the displacement current.
No one would try to keep track of all the charges”**

Paraphrase of email exchange, with permission

Conservation of Total Current

is important in

Biology

Conservation of Current

is

Practically Important

in

Understanding

Transporters

Oxidative

Phosphorylation

Photosynthesis

main processes in life

Applying Maxwell to Transporters

Sum of Currents in a Transporter = zero in 'small cell', mitochondrion, HHK, etc.

SO

Currents are Coupled in a Transporter in a 'small cell'

Currents are NOT coupled by Conservation of Current in standard bilayer setup

Source internet

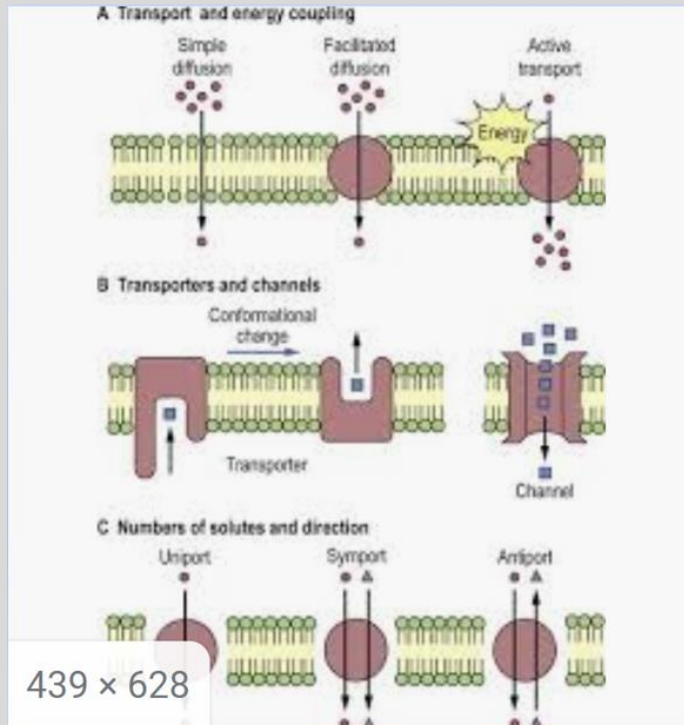

Conservation of Total Current

$$\text{div} \left(\mathbf{J}(x, t) + \epsilon_0 \frac{\partial \mathbf{E}(x, t)}{\partial t} \right) = 0$$

Liu, Hsieh, and Eisenberg (2016)
J Phys Chem B 120:2658-2669

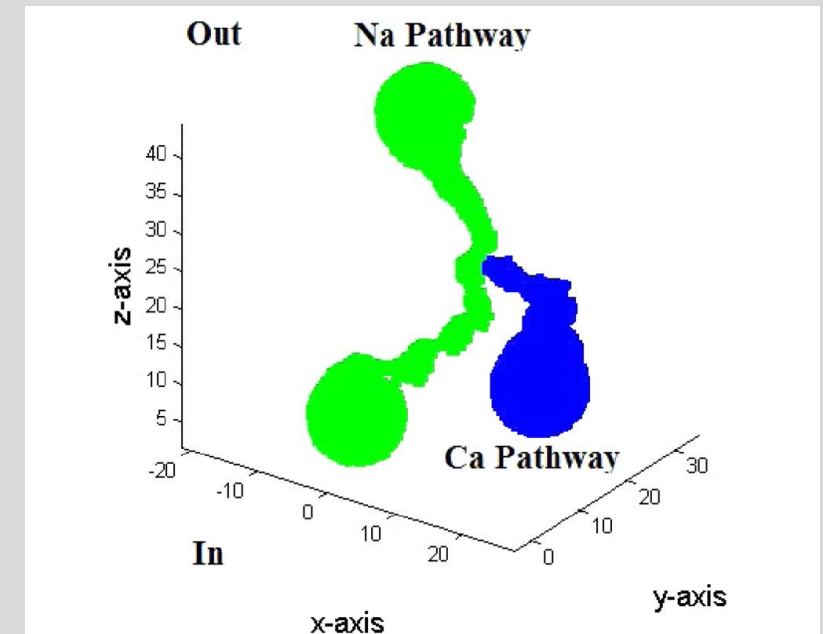
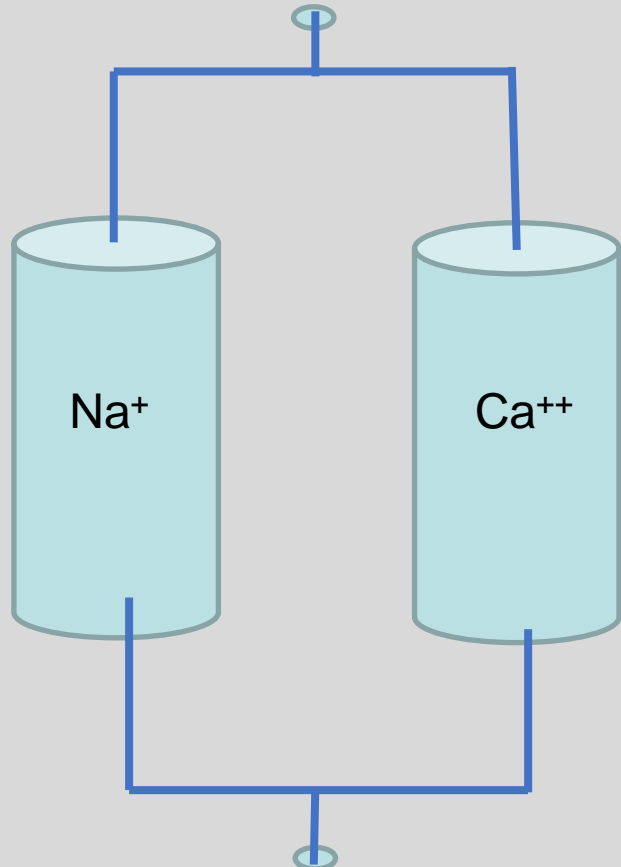

Figure 5. An inward-facing 3D model of Na⁺ and Ca²⁺ pathways in NCX.

Natural Setup: small cell, etc.

Homogeneous Neumann Boundary Condition for total current
Fig. 10 of Hodgkin Huxley Katz 1952



$$I = I_{Na} + I_{Ca} = 0$$

$$I_{Na} = -I_{Ca}$$

Bilayer Setup 'voltage clamp'

Inhomogeneous Dirichlet Condition
for Classic Voltage Clamp Hodgkin Huxley 1952

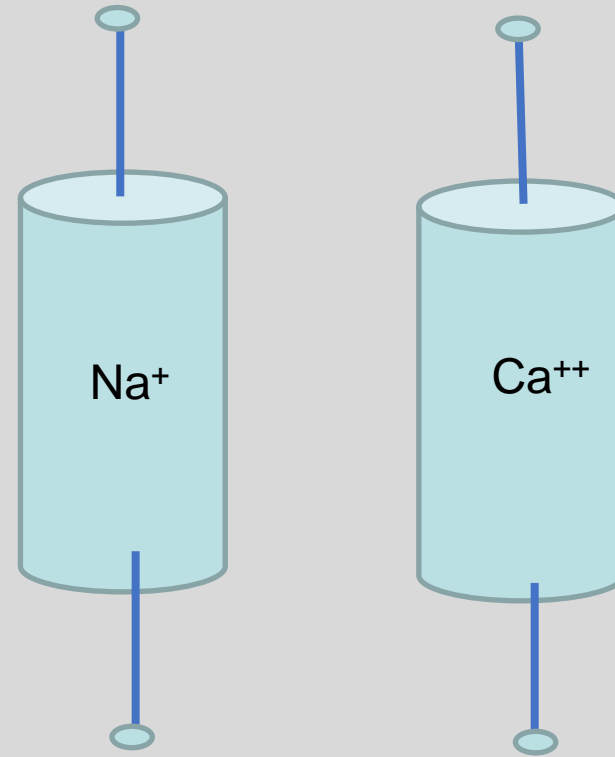

**Independent
Currents**

Biophysical Prediction

Coupling of Transporters Depends on Setup
not just the transporter itself

**Ratio of Fluxes J_{Ca}/J_{Na} is Different
in Vesicle (e.g., mitochondrion) and Bilayer**

Eisenberg (2020)

Electrodynamics Correlates Knock-on and Knock-off: Current is Spatially Uniform in Ion Channels.

Preprint on arXiv at <https://arxiv.org/abs/2002.09012>.

Applying Maxwell To Mitochondrion

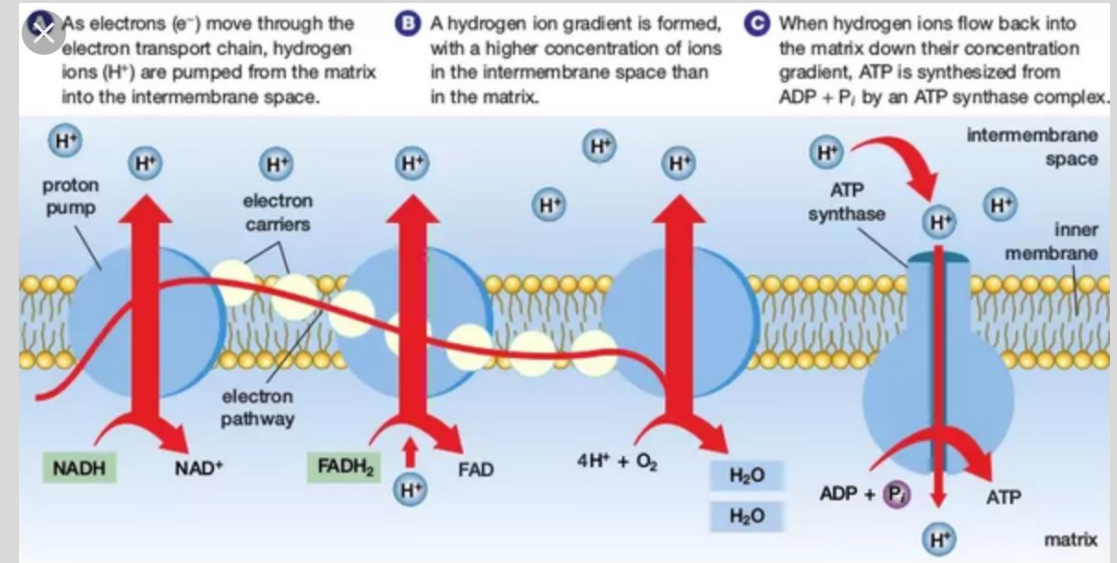
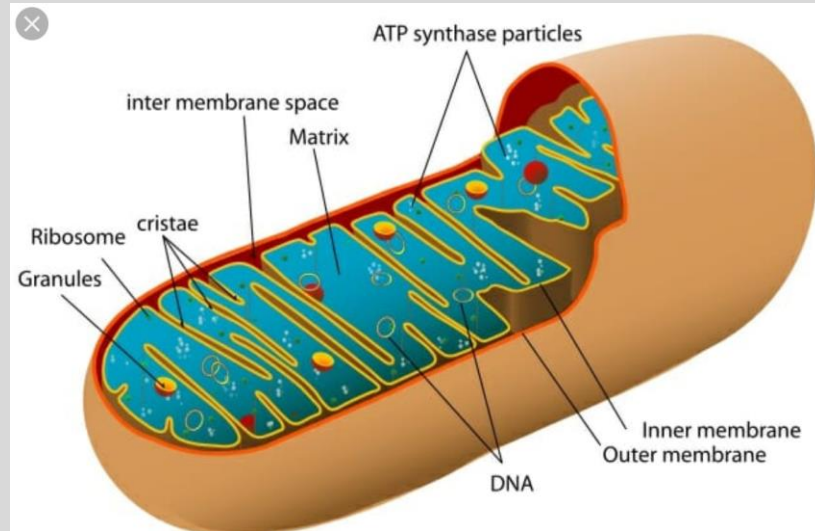

Depends on Conservation of Current

Source Internet

Paradigm Change

**Without Conservation of Current
Need to Know ALL charges at all times!!**

**Hopeless in large systems
where all ions interact with each other!**

NOTE

*Chemical Kinetics does not conserve current,
in its usual form*

Does Molecular Dynamics conserve current?

With Conservation of Current
no more difficult than
large circuit problems

Any Questions?

Extra Slides

What are the problems with textbook Maxwell Equations?

$\epsilon_r \epsilon_0$ is a hybrid

Polarization of Matter $(\epsilon_r - 1)\epsilon_0$

ϵ_r involves all movements of matter that do not translate mass,
roughly speaking

$(\epsilon_r - 1)\epsilon_0$

is as complex

as the motion of matter itself.

Seems hopeless to make a general theory

$\partial E / \partial t$ creating B field in a vacuum

is

Mysterious

Electric & Magnetic Fields takes on the Value that Conserves Current

Specifically,

E & B moves atoms

Creates the 'ethereal' current $\epsilon_0 \partial E / \partial t$

So total current $J + \epsilon_0 \partial E / \partial t$ is always conserved

Details and PROOF
including quantum mechanics at
<https://arxiv.org/abs/1609.09175>

**Profound Implications of One Dimensional Systems for atomic
view of ion channels**

**Spatial Variable does NOT appear
in description of current in a one
dimensional channel**

Spatial Variable does NOT appear in description of current in a one dimensional channel

Do you believe that?

If not, read proofs in
Eisenberg, R. S. 2019. Updating Maxwell with Electrons, Charge, and More Realistic
Polarization. arXiv 1904.09695
Eisenberg, Oriols, and Ferry. 2017. Dynamics of Current, Charge, and Mass. Molecular Based
Mathematical Biology 5:78-115 and arXiv preprint 1708.07400.

**Hopping Model is
COMPLETELY INAPPROPRIATE
for current that is uniform in x**

Do you believe that?

If not, read proofs in
Eisenberg, R. S. 2019. Updating Maxwell with Electrons, Charge, and More Realistic
Polarization. arXiv 1904.09695
Eisenberg, Oriols, and Ferry. 2017. Dynamics of Current, Charge, and Mass. Molecular Based
Mathematical Biology 5:78-115 and arXiv preprint 1708.07400.

**Spatial Variable does appear in
description of ion movement in a
one dimensional channel**

**Spatial Variable does NOT appear
in description of current in a one
dimensional channel**

**How take advantage
of this enormous simplification?**

Spatial Variable does NOT appear in description of current in a one dimensional channel

**How take advantage
of this enormous simplification?**

We need a Molecular Dynamics that

- 1) conserves current**
- 2) has one dielectric constant**
- 3) extends to biological time scales**

Spatial Variable does NOT appear in description of current in a one dimensional channel

**How take advantage
of this enormous simplification?**

Quasi-particle for current CONDUCTON

left over is DIFFUSION + POLARON.

$\Sigma = \text{PERMION}^*$

*Elber, Chen, Rojewska, and Eisenberg. 1995.
Sodium in gramicidin: An example of a permion.
Biophys. J. 68:906-924.

**With Conservation of Current
mitochondria are no more difficult than
large circuit problems**

Applying Maxwell to Mitochondria

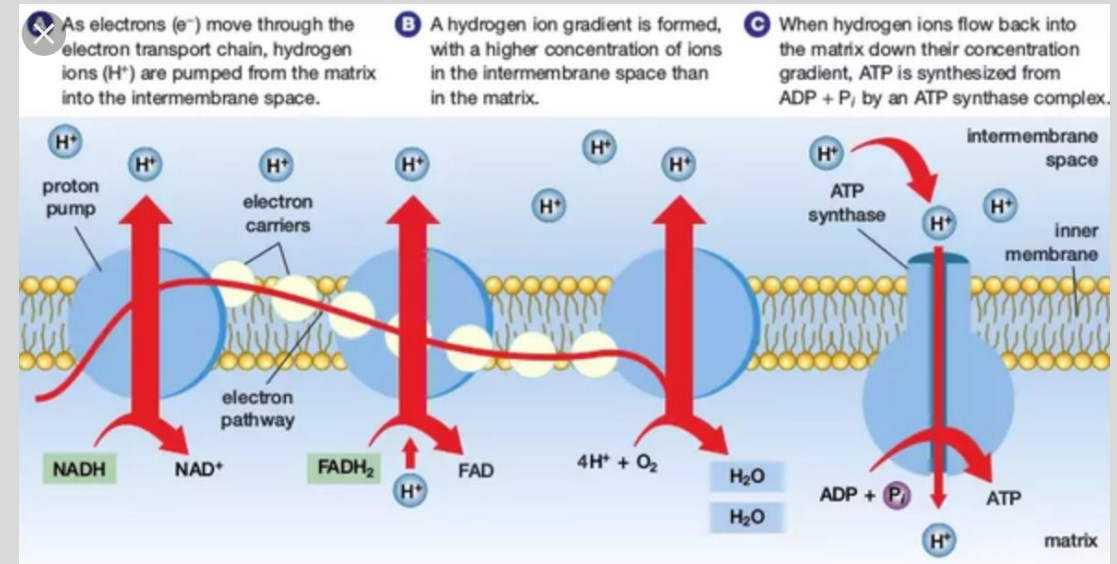
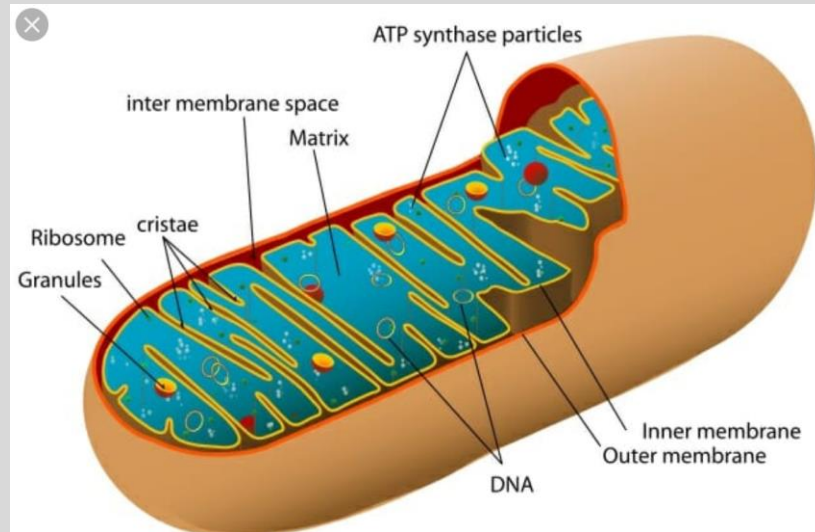

Seems Hopeless

But Stay Tuned for Future Work

Source: textbooks and internet

Applying Maxwell To Mitochondrion

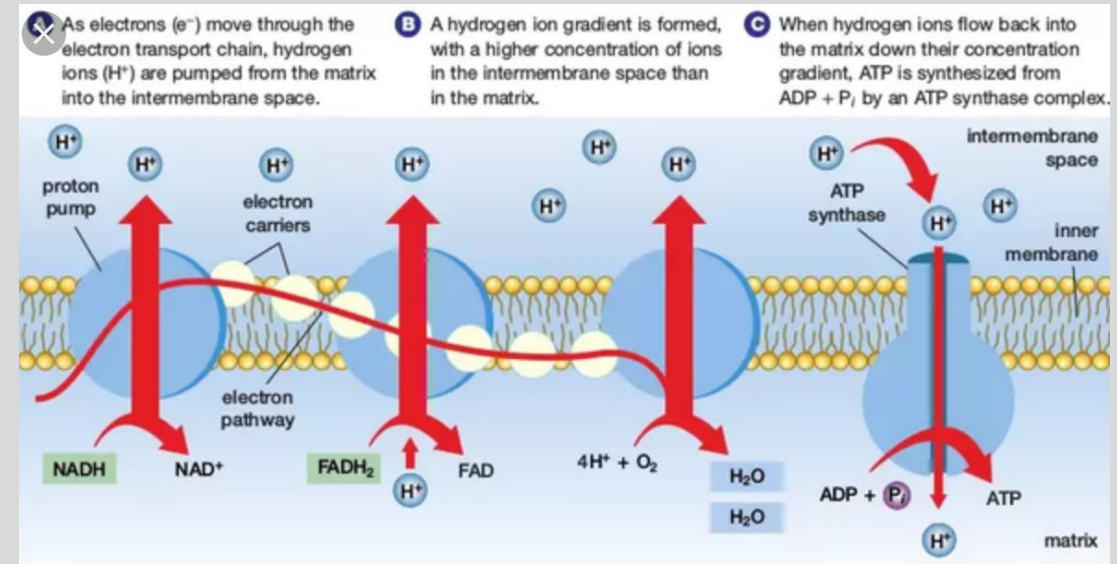
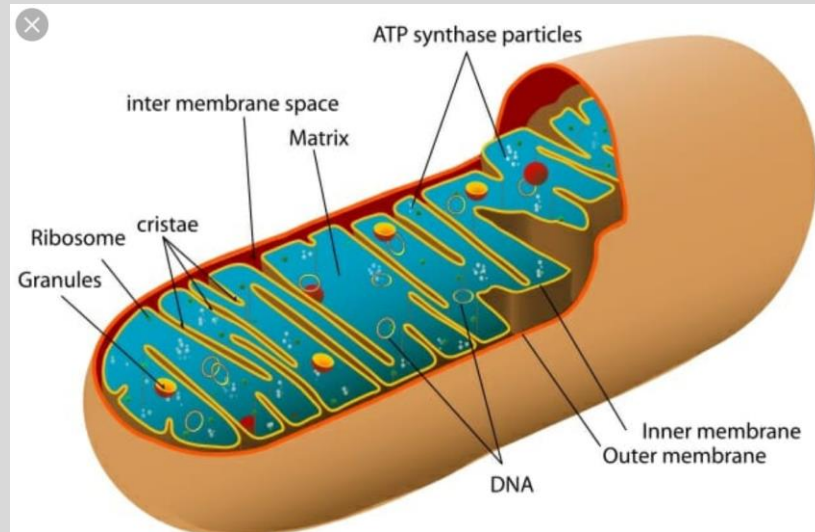

Depends on Conservation of Current

and depends on collaboration of Oscar Juarez, Chun Liu, and Bob Eisenberg

With Conservation of Current
no more difficult than
large circuit problems

Spatial Variable does NOT appear in description of current in a one dimensional channel

**How take advantage
of this enormous simplification?**

**Another way is to include equality of current
as a constraint in time averaging schemes**

e.g., of Ma and Liu

Ma, Li, and Liu. 2016.. arXiv:1605.04886.

Ma, Li, and Liu. 2016. arXiv:1606.03625.

Derivation of Kirchhoff's Law is at DC

Derivation of Kirchhoff's law is about fluxes

How can that work in a computer at 10^{-10} sec?

References and Proofs in

Eisenberg (2019) **Kirchhoff's Law can be Exact.** arXiv: 1905.13574

Eisenberg, Gold, Song, and Huang (2018)
What Current Flows Through a Resistor?
arXiv:1805.04814

Traditional Form of Maxwell Equations Cannot be Used

Maxwell's equations do not deal with
Diffusion
Convection
Complex materials
Complicated dielectric properties

Eisenberg, 2019. **Dielectric Dilemma**. arXiv: 1901.10805.

It is necessary to update Maxwell's Equations
to see how
Kirchhoff's law & Conservation of Current
apply to
Complex Liquids
and
Complex Biological Systems

Eisenberg, R. S. 2019. Updating Maxwell with Electrons, Charge, and More Realistic Polarization. arXiv 1904.09695

Eisenberg, Oriols, and Ferry. 2017. Dynamics of Current, Charge, and Mass. Molecular Based Mathematical Biology 5:78-115 and arXiv preprint 1708.07400.

It is necessary to update Maxwell's Equations

<https://arxiv.org/abs/1904.09695>

Not just my opinion

This is the opinion* of Nobel Prize winners in Physics,

Richard Feynman

(quantum electrodynamics)

and

Edward Purcell

(nuclear magnetic resonance)

*p. 10-7 of Feynman, Leighton, and Sands. 1963. *Mainly Electromagnetism and Matter*

*p. 506 of Purcell and Morin. 2013. *Electricity and Magnetism*

What are the PHYSICAL problems with traditional Maxwell Equations?

Maxwell's equations do not deal with

Diffusion

Convection

Complex materials

Complicated dielectric properties

*Indeed, Maxwell's original equations do not include ions or electrons or their movement!
Textbook treatments do not deal with other forces like diffusion or convection at all.*

Eisenberg, 2019. **Dielectric Dilemma**. arXiv: 1901.10805.

**NOT hopeless,
Maxwell Predicts Important Biophysics
Independent
of details of the Mitochondrion
if a
branched
One-dimensional Formulation
is appropriate**

Inside Channels

PROFOUND SIMIPLIFICATION

If we can figure out how to exploit it

Profound Implications of One Dimensional Systems for atomic view of ion channels

**Current is equal everywhere in a channel
At all times and under all conditions
that the Maxwell Equations Apply**

Paradigm Change

What are the problems with textbook Maxwell Equations?

$\epsilon_r \epsilon_0$ is a hybrid

Polarization of Matter $(\epsilon_r - 1)\epsilon_0$

ϵ_r involves all movements of matter that do not translate mass,
roughly speaking

$(\epsilon_r - 1)\epsilon_0$
is as complex
as the motion of matter itself.

Seems hopeless to make a general theory

Continuity of Current is Exact in Kelvin's Submarine Telegraph

$$i_{\text{Newfoundland}} = i_{\text{Ireland}}$$

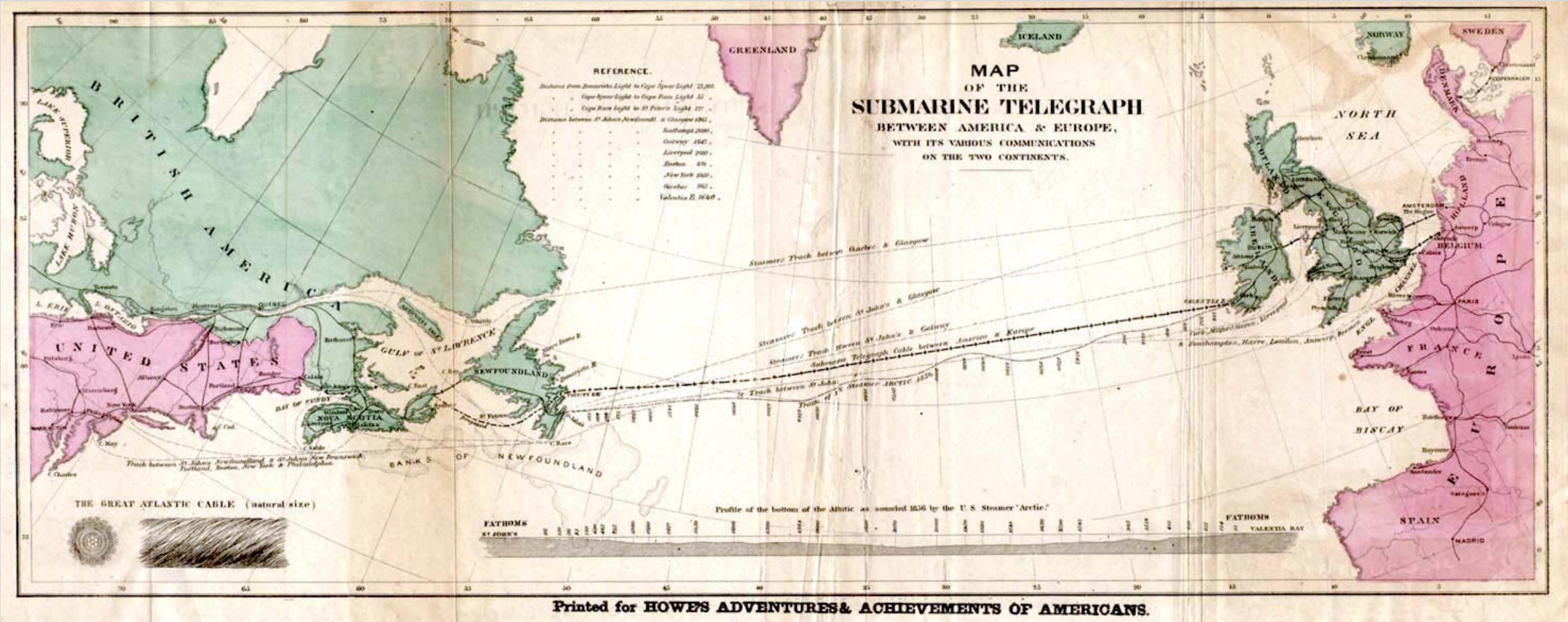

How can that possibly be true?

**It is NOT necessary to know the charges
to understand one crucial property of current.**

**Total Current is conserved
independent of any property of charge or matter**

Conservation of Current

$$\mathbf{div} \mathbf{J}_{total} = 0$$

Applying Maxwell to Transporters

Natural Setting

- 1) Sum of Currents in a Transporter is zero in 'small cell', mitochondrion, etc.
- 2) Currents are Coupled in a Transporter in a natural setting by Maxwell

Experimental Setting

- 3) Bilayer set up does NOT require currents to sum to zero.
Bilayer setup sets voltage across transporter, currents are not controlled.
- 4) So transporter currents are NOT coupled by Conservation of Current
in standard bilayer setup

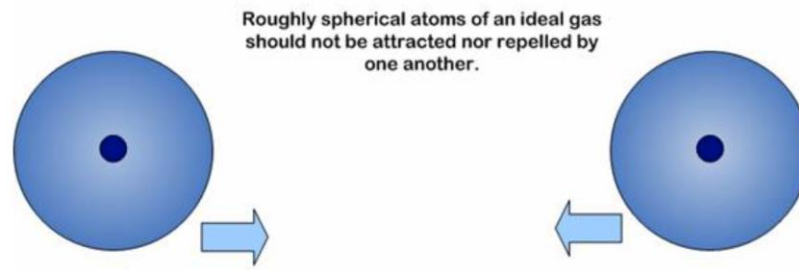

A real gas atom can have an instantaneous dipole. Partial charges on one atom cause a neighboring atom to distort due to the electrostatic attractions/repulsions of their electron clouds.

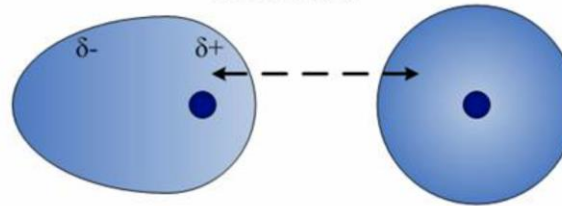

Attractions between opposite partial charges of neighboring induced dipoles cause atoms to "stick together" for a very short time.

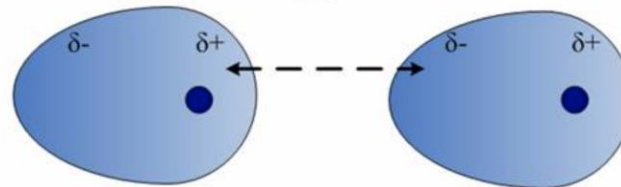

Source Internet

Polarization of Electron Orbitals